



CATÁLOGO Ferragens



DOBRADIÇA ENCARTELADA

CONTÉM 3 PEÇAS+PARAFUSOS

PALM	POL.	PALM	POL.
3706	3.1/2"	18870	4"
LIGHT MAIS FINA (1,2mm)		CHAPA GROSSA (1,5mm)	

PALM	POL.
3703	1.1/2"
3700	2"
3704	2.1/2"
3701	3"
3705	3.1/2"
3702	4"



DOBRADIÇA ZINCADA



CONTÉM 3 PEÇAS+PARAFUSOS

PALM	POL.
3722	1.1/2"
3719	2"
3723	2.1/2"
3720	3"
3724	3.1/2"
3721	4"



DOBRADIÇA POLIDA



CONTÉM 3 PEÇAS+PARAFUSOS

PALM	POL.
3753	2"
3756	2.1/2"
3754	3"
3757	3.1/2"
3755	4"



DOBRADIÇA PRETA



CONTÉM 3 PEÇAS+PARAFUSOS

PALM	POL.
3740	1.1/2"
3737	2"
3741	2.1/2"
3738	3"
3742	3.1/2"
3739	4"

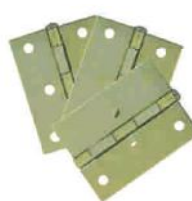

DOBRADIÇA BICROMATIZADA



CONTÉM 3 PEÇAS+PARAFUSOS

PALM	POL.
3768	2"
3771	2.1/2"
3769	3"
3772	3.1/2"
3770	4"



DOBRADIÇA COLONIAL S/ ANEL



CONTÉM 3 PEÇAS+PARAFUSOS

PALM	POL.
3781	3"x2.1/2"
3784	3.1/2"x3"
3783	3.1/2"
3782	4"



DOBRADIÇA COLONIAL C/ ANEL





FERRAGENS

UM MIX DE PRODUTOS PARA VOCÊ

ORCA®

DISTRIBUIDORA

DOBRADIÇA ZINCADA

PALM	POL.
3692	3.1/2"

LIGHT MAIS FINA (1,2mm)



PALM	POL.
18861	4"

CHAPA GROSSA (1,5mm)



PALM	POL.
3689	1.1/2"
3686	2"
3690	2.1/2"

PALM	POL.
3687	3"
3691	3.1/2"
3688	4"

DOBRADIÇA POLIDA

PALM	POL.
3710	1.1/2"
3707	2"
3711	2.1/2"

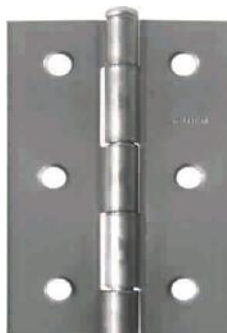

PALM	POL.
3708	3"
3712	3.1/2"
3709	4"

DOBRADIÇA POLIDA

PALM	TAMANHO
25503	3"x3"x2,25mm
25504	3.1/2"x3"x2,25mm
24250	3"x2.1/2"x1,9mm

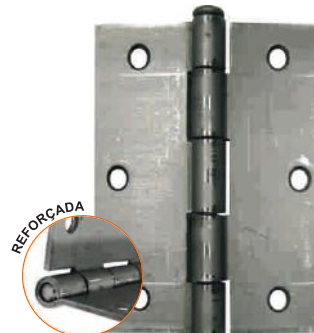

P/ SERRALHEIRO REFORÇADA

DOBRADIÇA PRETA

PALM	POL.
3743	2"
3746	2.1/2"
3744	3"



DOBRADIÇA BICROMATIZADA

PALM	POL.
3728	1.1/2"
3725	2"
3729	2.1/2"

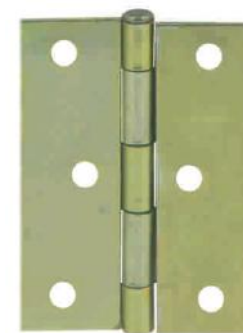

DOBRADIÇA COLONIAL S/ ANEL

PALM	POL.
3758	2"
3761	2.1/2"
3759	3"

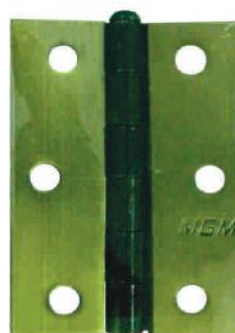

DOBRADIÇA COLONIAL C/ ANEL

PALM	POL.
3773	3"x2.1/2"
3776	3.1/2"x3"

PALM	POL.
3775	3.1/2"
3774	4"



PARAFUSO CHIPBOARD CABEÇA CHATA (PHILLIPS)

PARAFUSOS PRETO P/ DOBRADIÇAS GRUPO.: 0007 ...

PALM	PARAFUSO
13014	4,0X20

PALM	PARAFUSO
13013	3,5X20

PALM	PARAFUSO
13563	3,0X16

PALM	PARAFUSO
13012	3,0X12

PALM	PARAFUSO
13011	2,5X12



MEDIDAS DE PARAFUSOS P/ INSTALAÇÕES DE DOBRADIÇAS

DOBRADIÇA	PARAFUSO
DOBRADIÇA DE 1.1/2"	PARAFUSO 3,0x12
DOBRADIÇA DE 2"	PARAFUSO 3,0x12
DOBRADIÇA DE 2.1/2"	PARAFUSO 3,0x16
DOBRADIÇA DE 3"	PARAFUSO 3,5x20
DOBRADIÇA DE 3.1/2"	PARAFUSO 3,5x20
DOBRADIÇA DE 4"	PARAFUSO 4,0x20

PARAFUSOS ZINCADO P/ DOBRADIÇAS GRUPO.: 0009 ...

PALM	PARAFUSO
13005	4,0X20

PALM	PARAFUSO
13009	3,5X20

PALM	PARAFUSO
13583	3,0X16

PALM	PARAFUSO
13003	3,0X12

PALM	PARAFUSO
13004	2,5X12



PARAFUSO CHIPBOARD CABEÇA CHATA (PHILLIPS)

PARAFUSOS BICROMATIZADO P/ DOBRADIÇAS GRUPO.: 0008 ...

PALM	PARAFUSO
13008	4,0X20

PALM	PARAFUSO
13010	3,5X20

PALM	PARAFUSO
13603	3,0X16

PALM	PARAFUSO
13006	3,0X12

PALM	PARAFUSO
13007	2,5X12



PARAFUSO ROSCA SOBERBA

PARAFUSOS PRETO P/ DOBRADIÇAS



PALM	PARAFUSO
100	2,8X12

PALM	PARAFUSO
101	2,8X16

PALM	PARAFUSO
102	3,2X16

PALM	PARAFUSO
103	3,5X20



KIT DOBRADIÇAS ENCARTELADAS

PALM QTDE		PALM QTDE	
3680 288		3682 336	
KIT MISTO C/ 240 CARTELAS			
DESCRIÇÃO	QTDE	DESCRIÇÃO	QTDE
POLIDA 4" C/ 03 UNID. E PARAFUSO	12	ZINCADA 1.1/2" C/ 03 UNID. E PARAFUSO	12
BICROMAT. 1.1/2" C/ 03 UNID. E PARAFUSO	12	ZINCADA 2" C/ 03 UNID. E PARAFUSO	12
BICROMAT. 2" C/ 03 UNID. E PARAFUSO	12	ZINCADA 2.1/2" C/ 03 UNID. E PARAFUSO	12
BICROMAT. 2.1/2" C/ 03 UNID. E PARAFUSO	12	ZINCADA 3" C/ 03 UNID. E PARAFUSO	12
BICROMAT. 3" C/ 03 UNID. E PARAFUSO	12	ZINCADA 3.1/2" C/ 03 UNID. E PARAFUSO	24
BICROMAT. 3.1/2" C/ 03 UNID. E PARAFUSO	24	ZINCADA 4" C/ 03 UNID. E PARAFUSO	12
BICROMAT. 4" C/ 03 UNID. E PARAFUSO	12	POLIDA 1.1/2" C/ 03 UNID. E PARAFUSO	12
OXIDADA 2" C/ 03 UNID. E PARAFUSO	12	POLIDA 2" C/ 03 UNID. E PARAFUSO	12
OXIDADA 2.1/2" C/ 03 UNID. E PARAFUSO	12	POLIDA 2.1/2" C/ 03 UNID. E PARAFUSO	12
OXIDADA 3" C/ 03 UNID. E PARAFUSO	12	POLIDA 3" C/ 03 UNID. E PARAFUSO	12
OXIDADA 3.1/2" C/ 03 UNID. E PARAFUSO	12	POLIDA 3.1/2" C/ 03 UNID. E PARAFUSO	12

PALM QTDE		PALM QTDE	
3682 336		3684 336	
KIT POLIDA C/ 215 CARTELAS			
DESCRIÇÃO	QTDE	DESCRIÇÃO	QTDE
POLIDA 1.1/2" C/ 03 UNID. E PARAFUSO	48	ZINCADA 1.1/2" C/ 03 UNID. E PARAFUSO	48
POLIDA 2" C/ 03 UNID. E PARAFUSO	48	ZINCADA 2" C/ 03 UNID. E PARAFUSO	48
POLIDA 2.1/2" C/ 03 UNID. E PARAFUSO	48	ZINCADA 2.1/2" C/ 03 UNID. E PARAFUSO	48
POLIDA 3" C/ 03 UNID. E PARAFUSO	48	ZINCADA 3" C/ 03 UNID. E PARAFUSO	48
POLIDA 3.1/2" C/ 03 UNID. E PARAFUSO	96	ZINCADA 3.1/2" C/ 03 UNID. E PARAFUSO	96
POLIDA 4" C/ 03 UNID. E PARAFUSO	48	ZINCADA 4" C/ 03 UNID. E PARAFUSO	48

PALM QTDE		PALM QTDE	
3681 240		3683 240	
KIT POLIDA C/ 210 CARTELAS			
DESCRIÇÃO	QTDE	DESCRIÇÃO	QTDE
POLIDA 1.1/2" C/ 03 UNID. E PARAFUSO	36	ZINCADA 1.1/2" C/ 03 UNID. E PARAFUSO	36
POLIDA 2" C/ 03 UNID. E PARAFUSO	36	ZINCADA 2" C/ 03 UNID. E PARAFUSO	36
POLIDA 2.1/2" C/ 03 UNID. E PARAFUSO	36	ZINCADA 2.1/2" C/ 03 UNID. E PARAFUSO	36
POLIDA 3" C/ 03 UNID. E PARAFUSO	36	ZINCADA 3" C/ 03 UNID. E PARAFUSO	36
POLIDA 3.1/2" C/ 03 UNID. E PARAFUSO	60	ZINCADA 3.1/2" C/ 03 UNID. E PARAFUSO	60
POLIDA 4" C/ 03 UNID. E PARAFUSO	36	ZINCADA 4" C/ 03 UNID. E PARAFUSO	36

DOBRADIÇA DE FERRO ENCARTELADA

PALM QTDE		PALM QTDE	
3683 240		3684 336	
KIT ZINCADO C/ 210 CARTELAS			
DESCRIÇÃO	QTDE	DESCRIÇÃO	QTDE
ZINCADA 1.1/2" C/ 03 UNID. E PARAFUSO	36	ZINCADA 1.1/2" C/ 03 UNID. E PARAFUSO	48
ZINCADA 2" C/ 03 UNID. E PARAFUSO	36	ZINCADA 2" C/ 03 UNID. E PARAFUSO	48
ZINCADA 2.1/2" C/ 03 UNID. E PARAFUSO	36	ZINCADA 2.1/2" C/ 03 UNID. E PARAFUSO	48
ZINCADA 3" C/ 03 UNID. E PARAFUSO	36	ZINCADA 3" C/ 03 UNID. E PARAFUSO	48
ZINCADA 3.1/2" C/ 03 UNID. E PARAFUSO	60	ZINCADA 3.1/2" C/ 03 UNID. E PARAFUSO	96
ZINCADA 4" C/ 03 UNID. E PARAFUSO	36	ZINCADA 4" C/ 03 UNID. E PARAFUSO	48

DOBRADIÇA DE FERRO ENCARTELADA

PALM QTDE		PALM QTDE	
3684 336		3684 336	
KIT ZINCADO C/ 315 CARTELAS			
DESCRIÇÃO	QTDE	DESCRIÇÃO	QTDE
ZINCADA 1.1/2" C/ 03 UNID. E PARAFUSO	48	ZINCADA 1.1/2" C/ 03 UNID. E PARAFUSO	48
ZINCADA 2" C/ 03 UNID. E PARAFUSO	48	ZINCADA 2" C/ 03 UNID. E PARAFUSO	48
ZINCADA 2.1/2" C/ 03 UNID. E PARAFUSO	48	ZINCADA 2.1/2" C/ 03 UNID. E PARAFUSO	48
ZINCADA 3" C/ 03 UNID. E PARAFUSO	48	ZINCADA 3" C/ 03 UNID. E PARAFUSO	48
ZINCADA 3.1/2" C/ 03 UNID. E PARAFUSO	96	ZINCADA 3.1/2" C/ 03 UNID. E PARAFUSO	96
ZINCADA 4" C/ 03 UNID. E PARAFUSO	48	ZINCADA 4" C/ 03 UNID. E PARAFUSO	48

DOBRADIÇA DE FERRO ENCARTELADA





FERRAGENS

UM MIX DE PRODUTOS PARA VOCÊ

ORCA®

DISTRIBUIDORA

CADEADO LATÃO NACIONAL

PALM MM	TAMANHO	TAMANHO					
		A	B	C	D	E	F
2201 20	CAD 20 MM	23,0	24,0	14,0	4,0	11,0	12,5
	CAD 25 MM	28,0	29,0	19,5	4,8	13,0	14,5
2202 25	CAD 25 MM HASTE MÉDIA	28,0	29,0	25,0	4,8	13,0	14,5
	CAD 30 MM	32,0	30,0	24,0	5,5	14,5	14,5
2203 30	CAD 30 MM HASTE MÉDIA	32,0	30,0	40,0	5,5	14,5	14,5
	CAD 30 MM HASTE LONGA	32,0	30,0	71,5	5,5	14,5	14,5
2204 35	CAD 35 MM	35,0	33,0	25,0	6,3	17,0	14,5
2205 40	CAD 35 MM HASTE LONGA	35,0	33,0	72,5	6,3	17,0	14,5
16803 45	CAD 40 MM	40,0	36,0	28,0	6,3	21,0	14,5
	CAD 45 MM	45,0	38,5	34,0	8,0	22,5	14,5
2206 50	CAD SEG. 25 MM	25,0	25,0	15,5	4,0	10,5	12,0
28738 60	CAD SEG. 40 MM	39,0	41,5	29,0	7,0	18,0	17,5

PADO

ACOMPANHA CHAVE



CADEADO LATONADO NACIONAL

PALM MM	TAMANHO	TAMANHO					
		A	B	C	D	E	F
2207 20	CAD 20 MM	23,0	24,0	14,0	4,0	11,0	12,5
	CAD 25 MM	28,0	29,0	19,5	4,8	13,0	14,5
2208 25	CAD 25 MM HASTE MÉDIA	28,0	29,0	28,0	4,8	13,0	14,5
	CAD 30 MM	32,0	30,0	24,0	5,5	14,5	14,5
2209 30	CAD 30 MM HASTE MÉDIA	32,0	30,0	40,0	5,5	14,5	14,5
	CAD 30 MM HASTE LONGA	32,0	30,0	71,5	5,5	14,5	14,5
2210 35	CAD 35 MM	35,0	33,0	25,0	6,3	17,0	14,5
2211 40	CAD 35 MM HASTE LONGA	35,0	33,0	72,5	6,3	17,0	14,5
17548 50	CAD 40 MM	40,0	36,0	28,0	6,3	21,0	14,5
	CAD 45 MM	45,0	38,5	34,0	8,0	22,5	14,5
	CAD SEG. 25 MM	25,0	25,0	15,5	4,0	10,5	12,0
	CAD SEG. 40 MM	39,0	41,5	29,0	7,0	18,0	17,5

Piller

LAND ACOMPANHA CHAVE



PALM MM	TAMANHO	TAMANHO					
		A	B	C	D	E	F
25387 20	CAD 20 MM	23,0	24,0	14,0	4,0	11,0	12,5
	CAD 25 MM	28,0	29,0	19,5	4,8	13,0	14,5
25392 25	CAD 25 MM HASTE MÉDIA	28,0	29,0	28,0	4,8	13,0	14,5
	CAD 30 MM	32,0	30,0	24,0	5,5	14,5	14,5
25393 30	CAD 30 MM HASTE MÉDIA	32,0	30,0	40,0	5,5	14,5	14,5
	CAD 30 MM HASTE LONGA	32,0	30,0	71,5	5,5	14,5	14,5
25394 35	CAD 35 MM	35,0	33,0	25,0	6,3	17,0	14,5
25395 40	CAD 35 MM HASTE LONGA	35,0	33,0	72,5	6,3	17,0	14,5
25396 50	CAD 40 MM	40,0	36,0	28,0	6,3	21,0	14,5
	CAD 45 MM	45,0	38,5	34,0	8,0	22,5	14,5
	CAD SEG. 25 MM	25,0	25,0	15,5	4,0	10,5	12,0
	CAD SEG. 40 MM	39,0	41,5	29,0	7,0	18,0	17,5

stam

ZAMAC ACOMPANHA CHAVE



CADEADO C/ CHAVE TETRA

COD. MM	PALM MM
28741 40	18772 50
28742 50	ZAMAC LATONADO
28744 60	Piller

LATÃO NACIONAL
PADO



CADEADO LATÃO

COD.	HASTE MM
28739	35/50 35
28740	35/75 35

PADO



CADEADO LATONADO NACIONAL

PALM MM	PALM MM	PALM MM
10092 35	25402 25	25405 30
ZAMAC	25404 30	25406 35

Piller

stam

stam



CADEADO ZAMAC PADO

COD. MM	COD. MM
28746 25	28745 25
SEGREGO PRETO	SEGREGO PRATA

PADO



FERROLHO CHATO TIPO LEVE S/ PORTA CADEADO

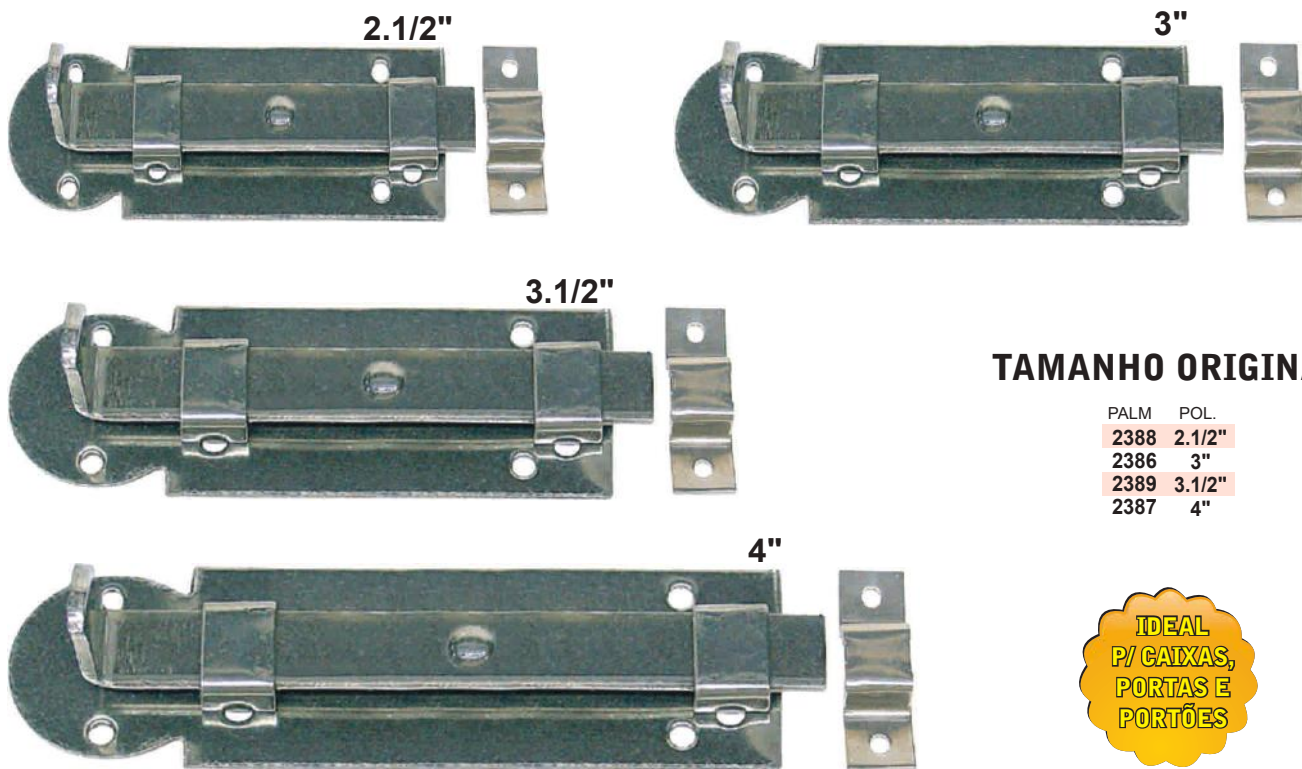

TAMANHO ORIGINAL

PALM	POL.
2388	2.1/2"
2386	3"
2389	3.1/2"
2387	4"

IDEAL P/ CAIXAS, PORTAS E PORTÕES

FERROLHO LATÃO ANTI FERRUGEM

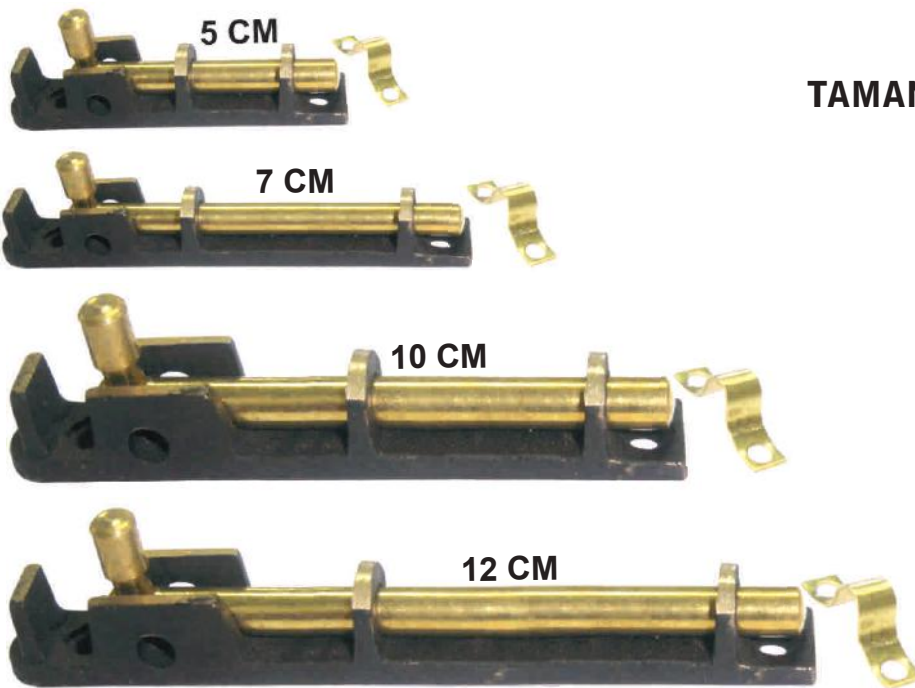

TAMANHO ORIGINAL

PALM	CM
2401	5
2402	7
2403	10
2404	12

**USADO EM
EMBARCAÇÕES E
MÓVEIS PRÓXIMO
A MAREIA**

TARGETA ZINCADA

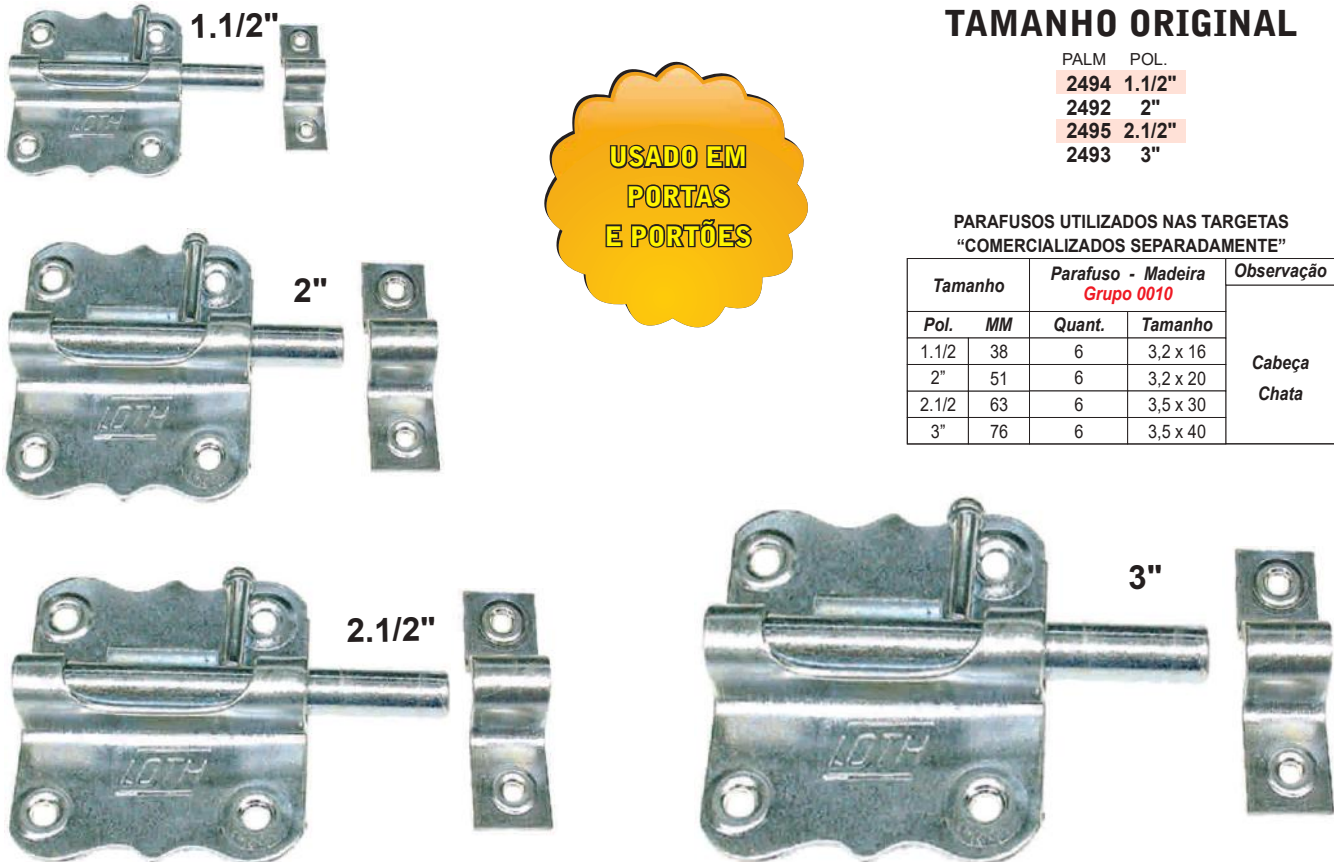

TAMANHO ORIGINAL

PALM	POL.
2494	1.1/2"
2492	2"
2495	2.1/2"
2493	3"

**USADO EM
PORTAS
E PORTÕES**

PARAFUSOS UTILIZADOS NAS TARGETAS
"COMERCIALIZADOS SEPARADAMENTE"

Tamanho		Parafuso - Madeira Grupo 0010		Observação
Pol.	MM	Quant.	Tamanho	
1.1/2	38	6	3,2 x 16	Cabeça Chata
2"	51	6	3,2 x 20	
2.1/2	63	6	3,5 x 30	
3"	76	6	3,5 x 40	



FECHO CHATO BICROMATIZADO P/ CADEADO

PARAFUSOS UTILIZADOS NOS FECHOS CHATOS
"COMERCIALIZADOS SEPARADAMENTE"

Tamanho		Parafuso - Madeira Grupo 0010		Obs.:
Pol.	MM	Quant.	Tamanho	Cabeça Chata
3"	76	6	3,5 x 20	
4"	101	6	3,8 x 22	
5"	127	6	4,2 x 30	
6"	152	6	4,2 x 40	

TAMANHO ORIGINAL

PALM	POL.
2363	2"
2364	3"
2365	4"
2366	5"
2367	6"

**IDEAL
P/ PORTAS E
PORTÕES**

2"

CHAPA 1,5mm
LINGÜETA 3,2mm



3"

CHAPA 1,75mm
LINGÜETA 4,5mm



4"

CHAPA 2mm
LINGÜETA 4,5mm



5"

CHAPA 2mm
LINGÜETA 4,8mm



6"

CHAPA 2mm
LINGÜETA 4,8mm



FECHO CHATO ZINCADO P/ CADEADO

PARAFUSOS UTILIZADOS NOS FECHOS CHATOS
"COMERCIALIZADOS SEPARADAMENTE"

Tamanho		Parafuso - Madeira Grupo 0010		Obs.:
Pol.	MM	Quant.	Tamanho	Cabeça Chata
3"	76	6	3,5 x 20	
4"	101	6	3,8 x 22	
5"	127	6	4,2 x 30	
6"	152	6	4,2 x 40	

TAMANHO ORIGINAL

PALM	POL.
2369	2"
2370	3"
2371	4"
2372	5"
2373	6"

**IDEAL
P/ PORTAS E
PORTÕES**

2"

CHAPA 1,5mm
LINGÜETA 3,2mm

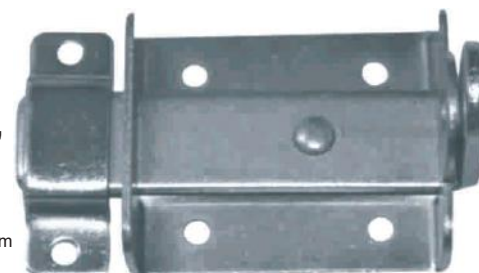

3"

CHAPA 1,75mm
LINGÜETA 4,5mm

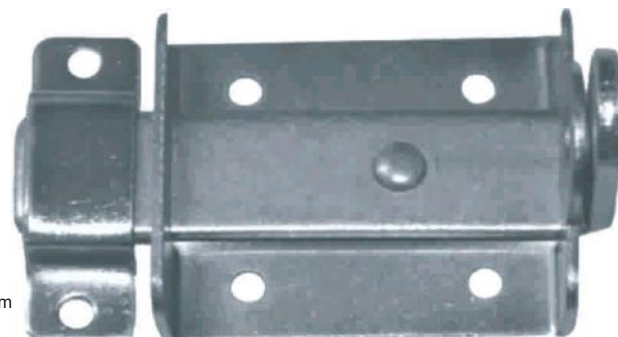

4"

CHAPA 2mm
LINGÜETA 4,5mm



5"

CHAPA 2mm
LINGÜETA 4,8mm



6"

CHAPA 2mm
LINGÜETA 4,8mm

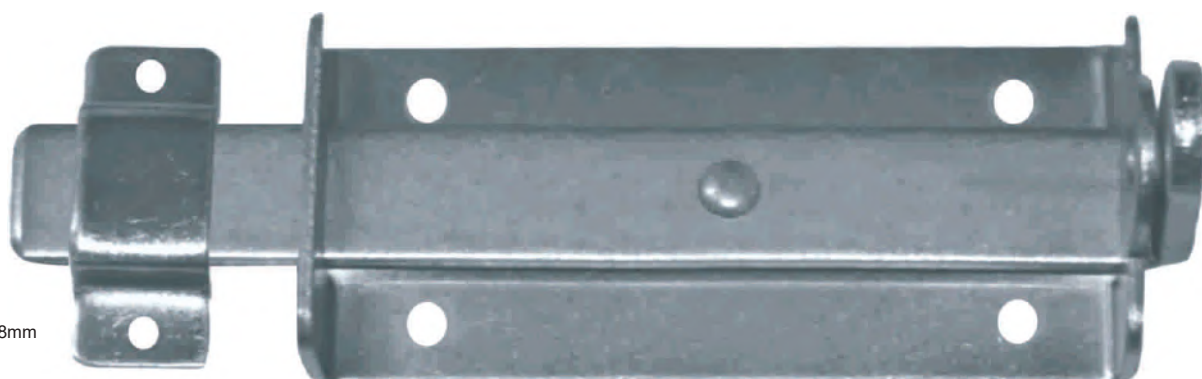



FERROLHO ZINCADO FIO REDONDO

PARAFUSOS UTILIZADOS NOS FECHOS CHATOS
"COMERCIALIZADOS SEPARADAMENTE"

Tamanho		Parafuso - Madeira Grupo 0010		Obs.:
Pol.	MM	Quant.	Tamanho	Cabeça Chata
3"	76	6	3,5 x 16	
4"	100	6	3,8 x 20	
5"	127	6	3,8 x 25	
6"	152	6	3,8 x 30	

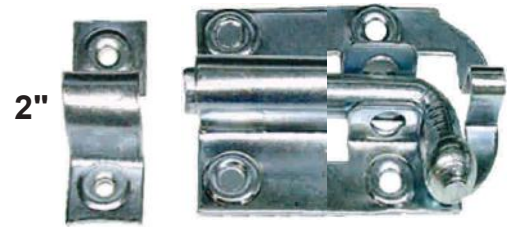

TAMANHO ORIGINAL

PALM	POL.
2390	2"
2395	2.1/2"
2391	3"
2392	4"
2393	5"
2394	6"



**IDEAL
P/ PORTAS E
PORTÕES**



FERROLHO PRETO FIO REDONDO

PARAFUSOS UTILIZADOS NOS FECHOS CHATOS
"COMERCIALIZADOS SEPARADAMENTE"

Tamanho		Parafuso - Madeira Grupo 0010		Obs.: Cabeça Chata
Pol.	MM	Quant.	Tamanho	
3"	76	6	3,5 x 16	
4"	100	6	3,8 x 20	
5"	127	6	3,8 x 25	
6"	152	6	3,8 x 30	

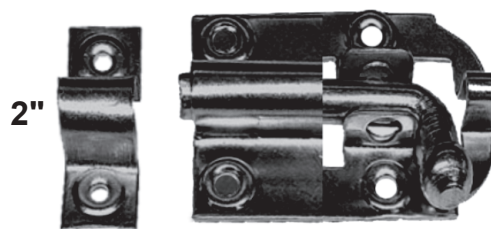

TAMANHO ORIGINAL

PALM	POL.
2396	2"
2400	2.1/2"
2397	3"
2398	4"
2399	5"

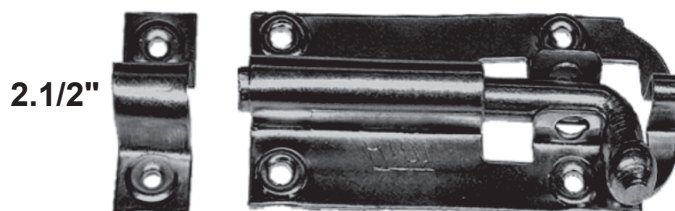

**IDEAL
P/ PORTAS E
PORTÕES**



PORTA CADEADO ZINCADO

TAMANHO ORIGINAL

PALM	TAMANHO
2460	2"
2464	2.1/2"
2461	3"
2465	3.1/2"
2462	4"
2466	4.1/2"

2"



2.1/2"



3"



3.1/2"



4"



4.1/2"



**IDEAL
P/ CAIXAS,
PORTAS E
PORTÕES**

CHAPA CAVALETE P/ CADEADO



PALM
2526
ORELHINHA
FURO 3/8"



* Não Acompanha Cadeado

GONZO

PALM POL.
3811 3/8"
3809 1/2"
3812 5/8"
3810 3/4"
3813 7/8"

LISO TORNEADO



PALM POL. PALM POL.
3817 3/8" **3819 7/8"**
3815 1/2" **3814 1"**
3818 5/8" **29486 1.1/2"**
3816 3/4"

TORNEADO C/ ABA



SUPORTE TRIANGULAR

PALM TAMANHO
8697 10mm
8698 15mm
P/ QUADROS/ESPELHOS C/ PREGO



TRINCO FERROLHO P/ PORTÃO

PALM
26685
1/2x8"



PALM
26686
1/2x10"



PALM
26687
1/2x12"



PALM
26688
1/2x15"



FECHO AUTOMÁTICO COMPLETO

PALM
24732
POLIDO



PALM
24731
BICROMATIZADO



PITÃO BICROMATIZADO

PALM BUCHA
2424 14x30 (1,9x16)
2425 15x30 (1,9x18)
2426 16x30 (2,1x21)
2427 16x40 (2,1x25)
BICROMATIZADO

14x30
(1,9x16)



15x30
(1,9x18)



16x30
(2,1x21)



16x40
(2,1x25)



17x40
(2,3x40)



18x45
(2,6x32)



19x50
(2,9x35)



21x80
(3,8x50)



ALDRAVA LATONADA



PALM MM
2432 16x50



PALM MM
2433 19x80



FERRAGENS

UM MIX DE PRODUTOS PARA VOCÊ

ORCA[®]
DISTRIBUIDORA

GANCHO BICROMATIZADO

PALM	BUCHA	PALM	BUCHA
2414	14x30 (1,8x21)	2419	17x60 (2,9x40)
2415	15x30 (1,9x25)	2420	18x70 (3,3x46)
2416	16x30 (2,1x31)	2421	19x80 (3,3x49)
2417	17x40 (2,3x35)	2422	21x90 (4,0x68)
2418	17x50 (2,6x37)		

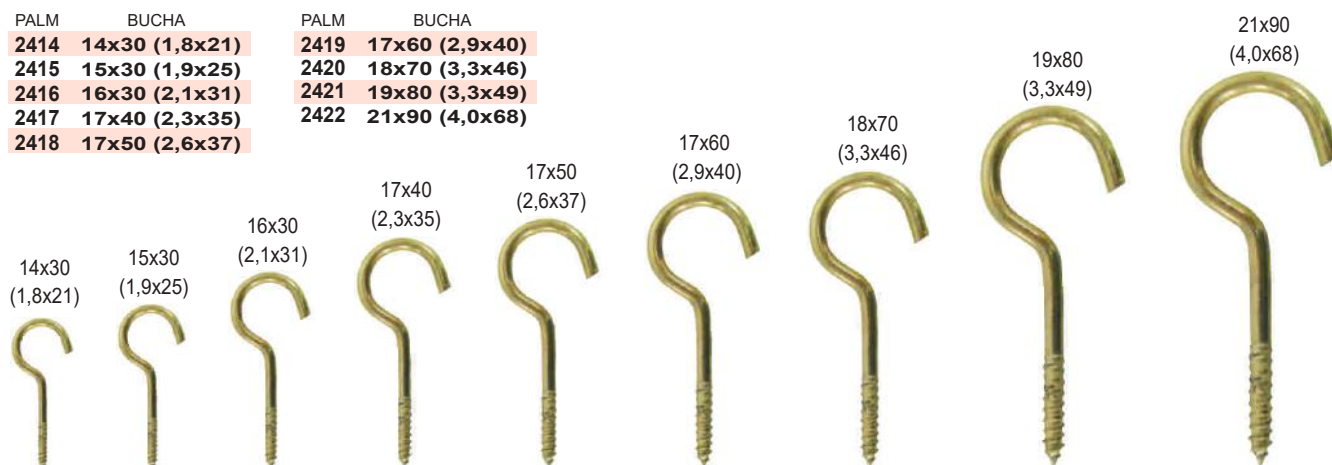

GANCHO ZINCADO C/ ABA E BUCHA S/ ANEL

POTE C/ GANCHO C/ ABA ZINCADO E BUCHA S/ ANEL

PALM	QTDE	BUCHAS
16559	100	S-06
16560	100	S-08
16561	100	S-10

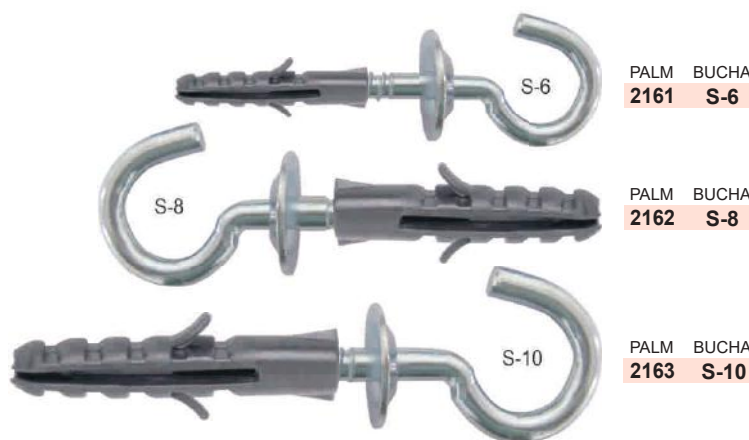

GANCHO ZINCADO C/ ABA E BUCHA C/ ANEL

POTE C/ GANCHO ZINCADO E BUCHA C/ ANEL

PALM	QTDE	BUCHAS
16731	100	S-06
16734	100	S-08
16737	100	S-10



GANCHO ZINCADO C/ BUCHA S/ ANEL

**POTE C/ GANCHO ZINCADO
E BUCHA S/ ANEL**



PALM	QTDE	BUCHAS
16550	200	S-06
16551	100	S-08
16553	100	S-10
16554	100	S-12

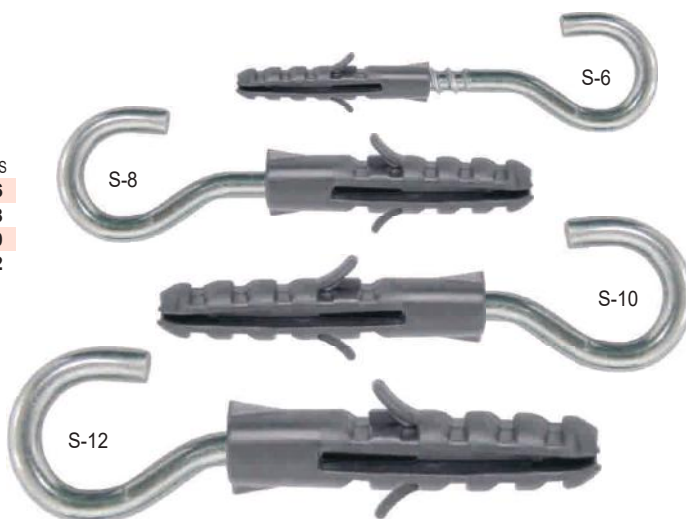

PALM	BUCHA
2154	S-6

PALM	BUCHA
2155	S-8

PALM	BUCHA
2156	S-10

PALM	BUCHA
2157	S-12

GANCHO ZINCADO C/ BUCHA C/ ANEL

**POTE C/ GANCHO
ZINCADO E BUCHA
C/ ANEL**



PALM	QTDE	BUCHAS
16706	200	S-06
16709	100	S-08
16712	100	S-10
16715	100	S-12

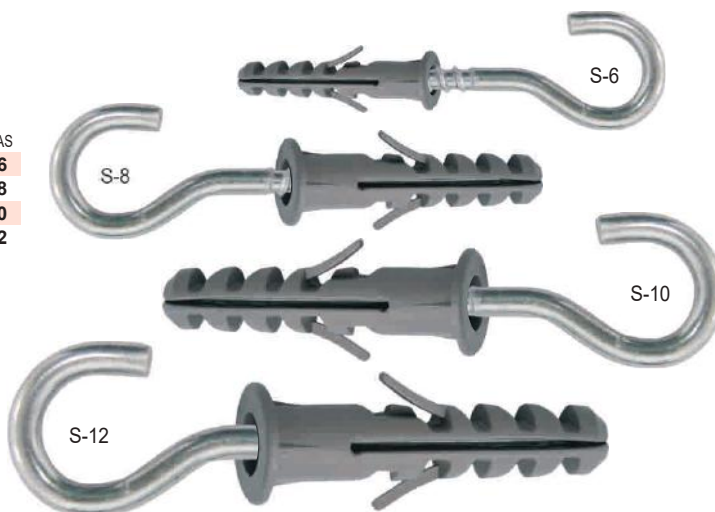

PALM	BUCHA
16759	S-6

PALM	BUCHA
16766	S-8

PALM	BUCHA
16769	S-10

PALM	BUCHA
16772	S-12

GANCHO ZINCADO C/ BUCHA BRANCA S/ ANEL

**POTE C/ GANCHO
ZINCADO E BUCHA
BRANCA S/ ANEL**



PALM	QTDE	BUCHAS
16707	200	S-06
16710	100	S-08
16713	100	S-10



PALM	BUCHA
16760	S-6

PALM	BUCHA
16767	S-8

PALM	BUCHA
16770	S-10

PALM	BUCHA
16773	S-12



FERRAGENS

UM MIX
DE PRODUTOS
PARA VOCÊ

ORCA[®]
DISTRIBUIDORA

PITÃO ZINCADO C/ BUCHA BRANCA C/ ANEL



PALM BUCHA
16788 S-6



PALM BUCHA
16791 S-8

PITÃO ZINCADO C/ BUCHA BRANCA S/ ANEL



PALM BUCHA
16787 S-6



PALM BUCHA
16790 S-8



PALM BUCHA
16793 S-10



PALM BUCHA
16796 S-12

PITÃO ZINCADO C/ BUCHA S/ ANEL



PALM BUCHA
2168 S-6



PALM BUCHA
2169 S-8



PALM BUCHA
2170 S-10



PALM BUCHA
2171 S-12

PITÃO ZINCADO C/ BUCHA C/ ANEL

POTE C/ PITÃO ZINCADO E BUCHA C/ ANEL

PALM	QTDE	BUCHAS
16718	200	S-06
16721	100	S-08
16725	100	S-10
16728	100	S-12



PALM BUCHA
16786 S-6



PALM BUCHA
16789 S-8



PALM BUCHA
16792 S-10



PALM BUCHA
16795 S-12

ESCÁPULA ZINCADA C/ BUCHA S/ ANEL

**POTE C/ ESCÁPULA ZINCADA
E BUCHA S/ ANEL**

PALM	QTDE	BUCHAS
16577	200	S-06
16579	100	S-08
16592	100	S-10



PALM	BUCHA
2182	S-6
2183	S-8
2184	S-10
2185	S-12

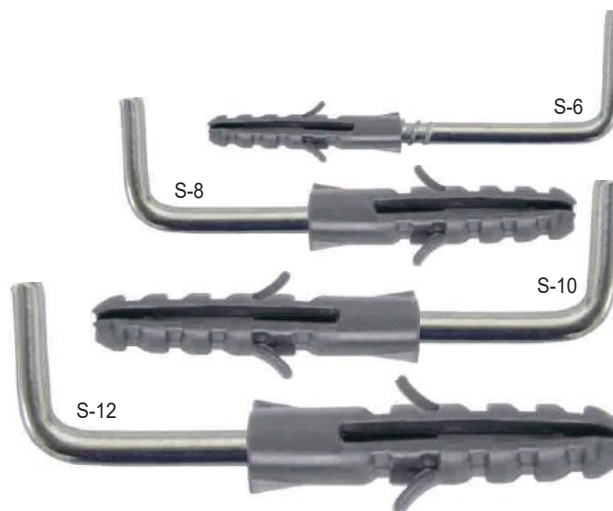

ESCÁPULA ZINCADO C/ BUCHA C/ ANEL

**POTE C/ ESCÁPULA ZINCADA
E BUCHA C/ ANEL**

PALM	QTDE	BUCHAS
16639	200	S-06
16640	100	S-08
16641	100	S-10
16642	100	S-12



PALM	BUCHA
16800	S-6
16801	S-8
16802	S-10
16804	S-12

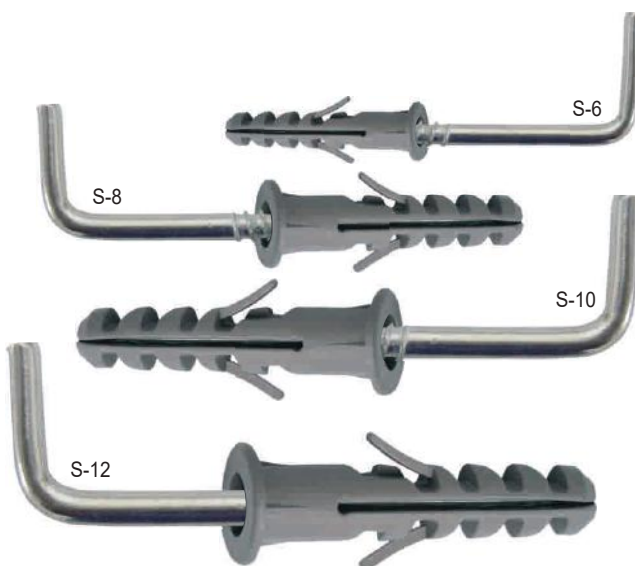

ESCÁPULA ZINCADO C/ BUCHA BRANCA S/ ANEL



PALM	BUCHA
16805	S-6
16806	S-8
16807	S-10





FERRAGENS

UM MIX
DE PRODUTOS
PARA VOCÊ

ORCA[®]
DISTRIBUIDORA

ESCÁPULA DE FERRO BICROMATIZADA C/ ROSCA

PALM	TAMANHO
17268	16x30
17269	17x50
17270	19x60
17271	21x70
17272	23x100

P/ MADEIRA 16X30



ESCÁPULA ZINCADA S/ BUCHA

PALM	BUCHA
2178	S-6
2179	S-8
2180	S-10
2181	S-12

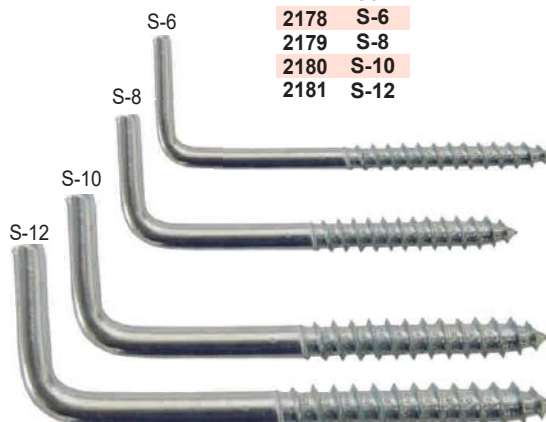

PITÃO ZINCADO C/ ABA S/ BUCHA

PALM	BUCHA
2172	S-6
2173	S-8
2174	S-10



GANCHO ZINCADO C/ ABA S/ BUCHA

PALM	BUCHA
2158	S-6
2159	S-8
2160	S-10

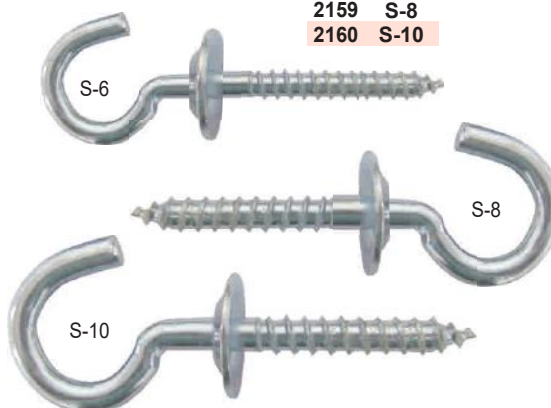

PITÃO ZINCADO S/ BUCHA

PALM	BUCHA
2164	S-6
2165	S-8
2166	S-10
2167	S-12



GANCHO ZINCADO S/ BUCHA

PALM	BUCHA
2150	S-6
2151	S-8
2152	S-10
2153	S-12

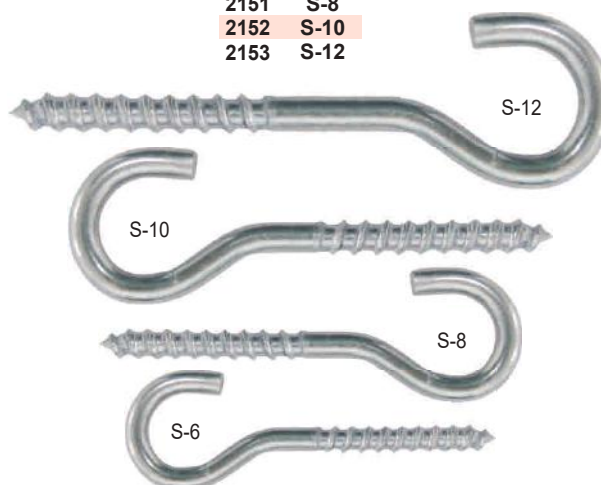

COMPOSIÇÃO DO EXPOSITOR PARA ENCARTELADOS

PALM
29475

COD.	DESCRIÇÃO	QTDE
29476	EXPOSITOR P/ ENCARTELADOS DIVERSOS C/ 40 GANCHOS - 87cmX64cm	1
5799	ENCART. PARAF. AUTO ATARRACHANTE C/ BUCHA DE NYLON S-5 - BLISTER 10 PEÇAS	10
5800	ENCART. PARAF. AUTO ATARRACHANTE C/ BUCHA DE NYLON S-6 - BLISTER 10 PEÇAS	10
5804	ENCART. PARAF. AUTO ATARRACHANTE C/ BUCHA DE NYLON S-7 - BLISTER 10 PEÇAS	10
5813	ENCART. PARAF. AUTO ATARRACHANTE C/ BUCHA DE NYLON S-8 - BLISTER 10 PEÇAS	10
5819	ENCART. PARAF. AUTO ATARRACHANTE C/ BUCHA DE NYLON S-10 - BLISTER 10 PEÇAS	6
13944	ENCART. PARAF. MADEIRA PHILLIPS 3,5x30 C/ BUCHA S-5 - BLISTER 10 PEÇAS	10
13945	ENCART. PARAF. MADEIRA PHILLIPS 3,8x40 C/ BUCHA S-6 - BLISTER 10 PEÇAS	10
13946	ENCART. PARAF. MADEIRA PHILLIPS 4,2x40 C/ BUCHA S-7 - BLISTER 10 PEÇAS	10
13947	ENCART. PARAF. MADEIRA PHILLIPS 5,5x45 C/ BUCHA S-8 - BLISTER 05 PEÇAS	10
13948	ENCART. PARAF. MADEIRA PHILLIPS 6,1x65 C/ BUCHA S-10 - BLISTER 05 PEÇAS	6
17441	ENCART. PARAF. SEXTAVADO ROSCA SOBERBA C/ BUCHA S-8 - 5 PECAS	10
17442	ENCART. PARAF. SEXTAVADO ROSCA SOBERBA C/ BUCHA S-10 - 5 PECAS	6
17443	ENCART. PARAF. SEXTAVADO ROSCA SOBERBA C/ BUCHA S-12 - 5 PECAS	6
29149	REBITE DE REPUXO ALUMÍNIO 4X10 (5/32X3/8) CARTELA 25 PEÇAS	10
29150	REBITE DE REPUXO ALUMÍNIO 4X12 (5/32X1/2) CARTELA 25 PEÇAS	10
29151	REBITE DE REPUXO ALUMÍNIO 4X15 (5/32X3/8) CARTELA 25 PEÇAS	10
29156	REBITE DE REPUXO ALUMÍNIO 4,8X12 (3/16X1/2) CARTELA 25 PEÇAS	10
2535	ENCART. BUCHA DE NYLON P/ FIXAÇÃO C/ ANEL S-6 - BLISTER 10 PEÇAS	10
2536	ENCART. BUCHA DE NYLON P/ FIXAÇÃO C/ ANEL S-8 - BLISTER 10 PEÇAS	10
2537	ENCART. BUCHA DE NYLON P/ FIXAÇÃO C/ ANEL Nº 10 - BLISTER 10 PEÇAS	10
2538	ENCART. BUCHA DE NYLON P/ FIXAÇÃO C/ ANEL Nº 12 - BLISTER 10 PEÇAS	6
2542	ENCART. GANCHO ZINCADO C/ BUCHA S-6 C/ 05 PEÇAS	10
2543	ENCART. GANCHO ZINCADO C/ BUCHA S-8 CARTELA C/ 05 PEÇAS	10
2544	ENCART. GANCHO ZINCADO C/ BUCHA S-10 CARTELA C/ 05 PEÇAS	6
2545	ENCART. GANCHO ZINCADO C/ BUCHA S 12 CARTELA C/ 05 PEÇAS	6
2549	ENCART. PITÃO ZINCADO C/ BUCHA S-6 - BLISTER 05 PEÇAS	10
2550	ENCART. PITÃO ZINCADO C/ BUCHA S-8 - BLISTER 05 PEÇAS	10
2551	ENCART. PITÃO ZINCADO C/ BUCHA S-10 - BLISTER 05 PEÇAS	6
2552	ENCART. PITÃO ZINCADO C/ BUCHA S-12 - BLISTER 05 PEÇAS	6
2556	ENCART. ESCAPULA ZINCADA C/ BUCHA S-6 - BLISTER 05 PEÇAS	10
2557	ENCART. ESCAPULA ZINCADA C/ BUCHA S-8 - BLISTER 05 PEÇAS	10
2558	ENCART. ESCAPULA ZINCADA C/ BUCHA S-10 - BLISTER 05 PEÇAS	6
2559	ENCART. ESCAPULA ZINCADA C/ BUCHA S-12 - BLISTER 02 PEÇAS	6
7990	ENCART. PREGO POLIDO C/ CABEÇA 8X8 (1,30mm x 18mm) - BLISTER 50 PEÇAS	10
7991	ENCART. PREGO POLIDO C/ CABEÇA 10X10 (1,50mm x 23mm) - BLISTER 50 PEÇAS	10
8286	ENCART. PREGO POLIDO C/ CABEÇA 12X12 (1,80mm x 28mm) - BLISTER 50 PEÇAS	10
8298	ENCART. PREGO POLIDO C/ CABEÇA 13X15 (2,00mm x 34mm) - BLISTER 20 PEÇAS	10
8292	ENCART. PREGO POLIDO C/ CABEÇA 15X15 (2,40mm x 34mm) - BLISTER 20 PEÇAS	10
8288	ENCART. PREGO POLIDO C/ CABEÇA 17X21 (3,00mm x 48mm) - BLISTER 20 PEÇAS	10
8309	ENCART. PREGO POLIDO C/ CABEÇA 17X27 (3,00mm x 62mm) - BLISTER 20 PEÇAS	10

EXPOSITOR PARA ENCARTELADOS - LINHA FIXAÇÃO

KIT ENCARTELADO C/ 40 GANCHOS E 356 CARTELAS





BUCHA BRANCA DE FIXAÇÃO P/ DRYWALL/ GESSO

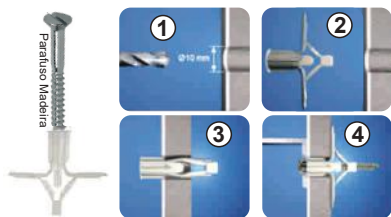

TIPOS DE FIXAÇÃO

Características	FLY 2 Pequena	FLY 3 Média	FLY 4 Grande
Ø Furo (mm)	10	10	10
Espessura do material base (mm)	4 - 16	13 - 23	24 - 32
Ø Parafuso (mm)	4,0 - 4,5	4,0 - 4,5	4,0 - 4,5
Comprimento da Bucha (mm)	35	40	45
Carga Recomendada (Kgf)	Drywall 1/2" 10 Drywall 5/8" 15	Drywall 5/8" 15	Drywall 2x1/2" 15

- * Todos tipos de materiais ocios: Gesso, drywall, forro e etc.;
- * Parafusos madeira ou auto-atarraxante;
- * Travas anti-giro; evita que a bucha rode dentro do furo;
- * Produzida com poliamida 100% NYLON;
- * Disponível também na versão PEAD (plástico);
- * NYLON ou PEAD são comercializadas em 3 tamanhos.

O comprimento do parafuso deve ser o comprimento da bucha mais espessura do objeto a ser fixado

PALM	Nº
2147	1
2148	2
2149	3

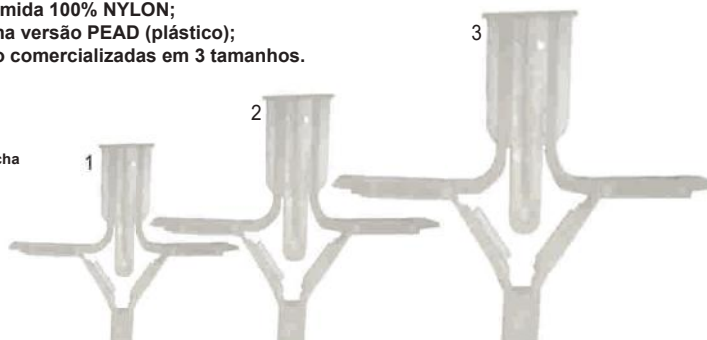

BUCHA VERMELHA

PALM	BUCHA
21288	S-6
21289	S-8
21290	S-10

BUCHA DE NYLON C/ ANEL PROFISSIONAL



PALM	BUCHA
21347	S-6
21348	S-8
21349	S-10
21350	S-12

BUCHA S/ ANEL PLÁSTICA



P/ TIJOLO OCO
S-12

BUCHA DE FIXAÇÃO S/ ANEL

PALM	BUCHA
2134	S-5
2135	S-6
2136	S-7
2137	S-8
2138	S-10
2139	S-12



BUCHA DE NYLON

BUCHA DRYFIX DE NYLON 32mm P/ DRYWALL/ GESSO

PALM
21291



BUCHA C/ ANEL CINZA

PALM	BUCHA
2144	S-6
2145	S-8
2146	S-10



P/ TIJOLO FURADO

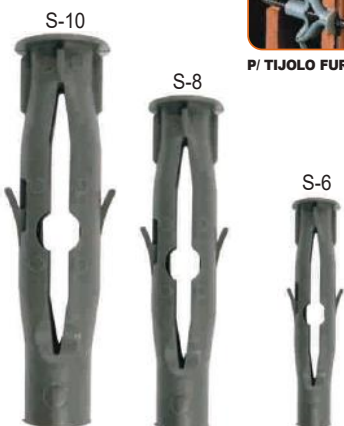

BUCHA DE FIXAÇÃO C/ ANEL

PALM	BUCHA
2140	S-6
16376	S-7
2141	S-8
2142	S-10
2143	S-12

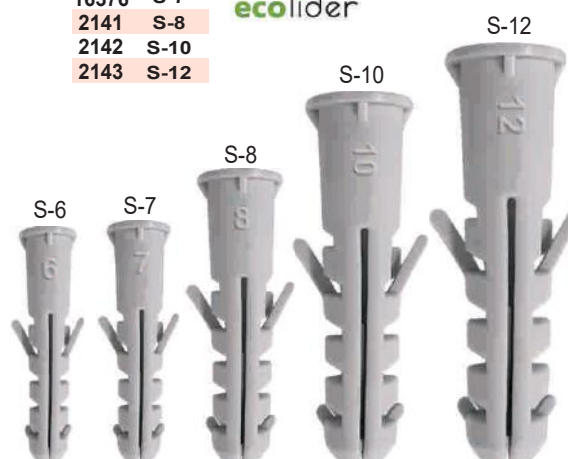

BUCHA P/ TIJOLO FURADO C/ ANEL CINZA

BUCHA DE NYLON

PALM	BUCHA
21292	S-6
21293	S-8
21345	S-10
21346	S-12

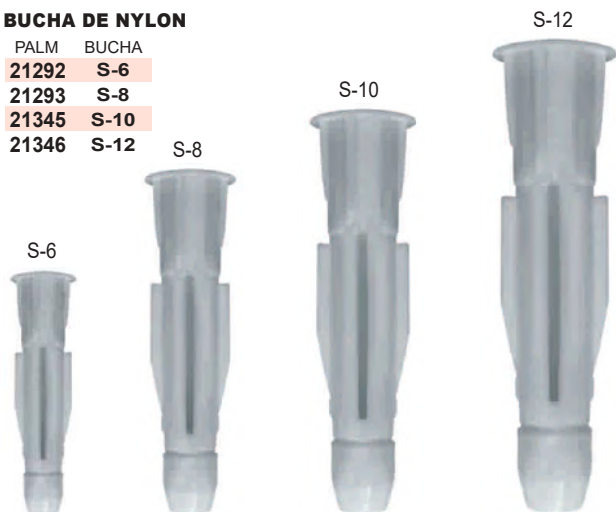

BUCHA P/ TIJOLO FURADO C/ ANEL BRANCA

BUCHA PLÁSTICA

PALM	BUCHA
20619	S-6
20620	S-8
20621	S-10
21351	S-12

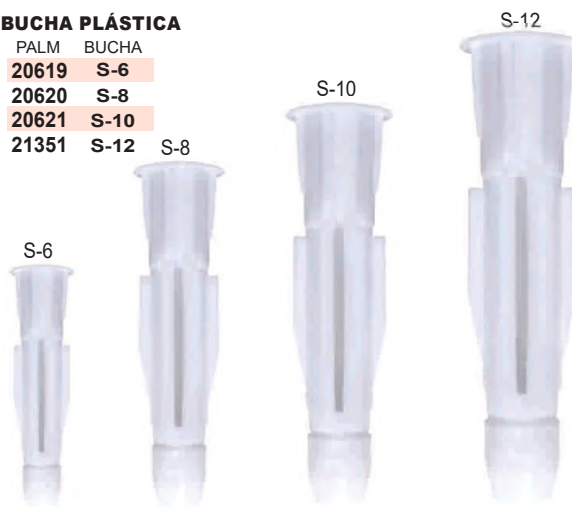

BUCHA BRANCA DE FIXAÇÃO S/ ANEL

PALM	BUCHA
16486	S-5
16487	S-6
16488	S-7
16489	S-8
16490	S-10
16491	S-12

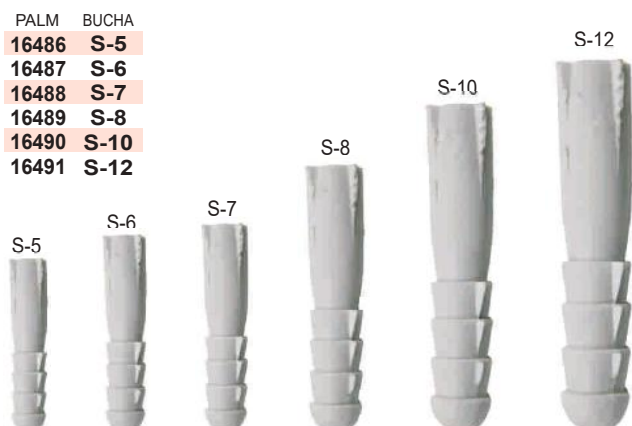

BUCHA BRANCA DE FIXAÇÃO C/ ANEL

PALM	BUCHA
16492	S-6
16494	S-8
16495	S-10
16496	S-12

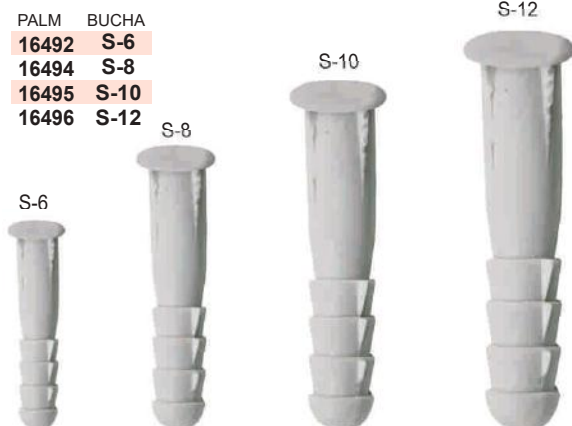

BUCHA CINZA DE FIXAÇÃO S/ ANEL

PALM	BUCHA
39468	S-5
39469	S-6
39470	S-7
39471	S-8
39472	S-10
39473	S-12



BUCHA CINZA DE FIXAÇÃO C/ ANEL

PALM	BUCHA
39476	S-6
39478	S-7
39479	S-8
39480	S-10
39483	S-12





FERRAGENS

UM MIX
DE PRODUTOS
PARA VOCÊ

ORCA[®]

DISTRIBUIDORA

BUCHA POLIPROPILENO VIRGEM P/ TIJOLO OCO ALTA DENSIDADE

PALM	BUCHA
39598	S-6
39599	S-8
39600	S-10
39601	S-12



BUCHA POLIPROPILENO VIRGEM P/ FIXACAO ALTA DENSIDADE

PALM	BUCHA
39595	S-6
39596	S-8
39597	S-10

CINZA



PALM	BUCHA
39592	S-6
39593	S-8
39594	S-10

VERDE



PARAFUSO PANELA C/ BUCHA S/ ANEL

PALM	BUCHAS	QTDE	BITOLA
9041	S-5	500	3,5x25
9042	S-6	500	4,2x32
9044	S-8	400	5,5x38
9021	S-10	200	6,3x50

POTE C/ PARAFUSO AUTO ATARRACHANTE E BUCHA S/ ANEL

CABEÇA PARAFUSO MADEIRA



PALM	BUCHA
1498	S-5



PALM	BUCHA
1499	S-6



PALM	BUCHA
1500	S-7



PALM	BUCHA
1501	S-8



PALM	BUCHA
1502	S-10



PARAFUSO PANELA C/ BUCHA C/ ANEL

PALM	BUCHAS	QTDE	BITOLA
16949	S-6	500	4,2x32
16957	S-7	500	4,2x32
16962	S-8	400	5,5x38
16970	S-10	200	6,3x50

POTE C/ PARAFUSO AUTO ATARRACHANTE E BUCHA C/ ANEL

CABEÇA PARAFUSO MADEIRA



PALM	BUCHA
16953	S-6



PALM	BUCHA
16959	S-7



PALM	BUCHA
16966	S-8



PALM	BUCHA
16972	S-10





PARAFUSO SEXTAVADO E BUCHA S/ ANEL

PALM	BUCHAS	QTDE	BITOLA
16981	S-8	100	3/16x45
16990	S-10	100	1/4x55
16997	S-12	100	5/16x65

POTE C/ PARAFUSO SEXTAVADO
ROSCA SOBERBA C/ BUCHA S/ ANEL

PALM	BUCHA
16977	S-8



SEXTAVADO ROSCA SOBERBA

PALM	BUCHA
16986	S-10



SEXTAVADO ROSCA SOBERBA

PALM	BUCHA
16993	S-12



SEXTAVADO ROSCA SOBERBA



PARAFUSO SEXTAVADO E BUCHA C/ ANEL

PALM	BUCHAS	QTDE	BITOLA
16982	S-8	100	3/16x45
16991	S-10	100	1/4x55
16998	S-12	100	5/16x65

POTE C/ PARAFUSO SEXTAVADO
ROSCA SOBERBA C/ BUCHA C/ ANEL

PALM	BUCHA
16978	S-8



SEXTAVADO ROSCA SOBERBA

PALM	BUCHA
16987	S-10



SEXTAVADO ROSCA SOBERBA

PALM	BUCHA
16994	S-12



SEXTAVADO ROSCA SOBERBA



PARAFUSO MADEIRA C/ BUCHA BRANCA S/ ANEL



PALM	BUCHA
17025	S-10



PALM	BUCHA
17019	S-8



PALM	BUCHA
17012	S-6



PALM	BUCHA
17009	S-5

POTE PARAFUSO PANELA E BUCHA BRANCA C/ ANEL



CABEÇA
PARAFUSO
MADEIRA



PALM	BUCHAS	QTDE	BITOLA
16952	S-6	500	4,2x32
16965	S-8	400	5,5x38

POTE C/ PARAFUSO AUTO
ATARRACHANTE E BUCHA BRANCA
C/ ANEL

PARAFUSO MADEIRA C/ BUCHA S/ ANEL

PALM	BUCHAS	QTDE	BITOLA
14089	S-5	500	3,2x25
14090	S-6	500	3,8x30
14091	S-7	500	4,2x30
14092	S-8	400	4,8x40
14093	S-10	200	5,5x50
14094	S-12	200	6,1x65

CABEÇA
PARAFUSO
MADEIRA



POTE C/ PARAFUSO MADEIRA
E BUCHA S/ ANEL



PALM
17028



PALM
17026



PALM
17021



PALM
17017



PALM
17014



PALM
17010

PARAFUSO MADEIRA C/ BUCHA C/ ANEL

PALM	BUCHAS	QTDE	BITOLA
16371	S-6	500	3,8x30
16372	S-7	500	4,2x30
16373	S-8	400	4,8x40
16374	S-10	200	5,5x50
16375	S-12	200	6,1x65

CABEÇA
PARAFUSO
MADEIRA



POTE C/ PARAFUSO MADEIRA
E BUCHA C/ ANEL



PALM
17027



PALM
17022



PALM
17018



PALM
17015



PALM
17011



FERRAGENS

UM MIX DE PRODUTOS PARA VOCÊ

ORCA[®]
DISTRIBUIDORA

POTE C/ BUCHA DE FIXAÇÃO

PALM	BUCHA	QTDE
16572	S-6	1000
16573	S-8	500
16574	S-10	300
16575	S-12	200

C/ ANEL



PALM	BUCHA	QTDE
16636	S-10	300
16637	S-12	200

BRANCA C/ ANEL



PALM	BUCHA	QTDE
16566	S-5	1000
16567	S-6	1000
16569	S-8	500
16570	S-10	400

S/ ANEL



SOQUETE MAGNÉTICO

PALM	MEDIDA/MM
14698	M6x65
14699	M8x65
14700	M10x65

PALM	MEDIDA/POLxMM
14675	1/4x65
14677	5/16x65
14676	3/8x65
14696	7/16x65
14697	1/2x65



PARAFUSO AUTO BROCANTE

PALM	MM	POLEGADA
2502	5,5x19	12x3/4
2503	5,5x22	12x7/8
2501	5,5x25	12x1"
10891	5,5x38	12x1.1/2
9749	5,5x50	12x2"
9750	5,5x63	12x2.1/2



P/ TELHA
ZINCO/ALUMÍNIO/
AMIANTO
CHAVE 5/16

PALM	MM	POLEGADA
6884	4,2x13	8x1/2
11986	4,2x16	8x5/8
11984	4,2x19	8x3/4
11985	4,2x25	8x1"

CABEÇA FLANGEADA
PHILLIPS C/ SERRILHA
PONTA TRAVANTE
P/ FORRO DE P.V.C.



PALM	MM	POLEGADA
17424	4,2x13	8x1/2
29910	4,2x16	8x5/8
29911	4,2x19	8x3/4
29912	4,2x25	8x1"

CABEÇA FLANGEADA
PONTA AGULHA
P/ FORRO DE P.V.C.



PONTEIRA MAGNÉTICA

PALM	MEDIDA/MM
14621	2x65
14622	2x75
14624	2x100

2 PONTAS PHILLIPS
1/4 PH2



PARAFUSO AUTO BROCANTE

PALM	MM	POLEGADA
25792	5,5x19	12x3/4
25798	5,5x22	12x7/8
25793	5,5x25	12x1"
25794	5,5x38	12x1.1/2
28652	5,5x50	12x2"
25795	5,5x63	12x2.1/2
25796	5,5x89	12x3.1/2
25797	5,5x100	12x4"

P/ TELHA
ZINCO/ALUMÍNIO/AMIANTO
CHAVE 5/16



PALM	MM	POLEGADA
25799	4,2x13	8x1/2
31141	4,2x16	8x5/8
30213	4,2x19	8x3/4
31142	4,2x25	8x1"
25800	4,8x19	10x3/4

CABEÇA FLANGEADA
PHILLIPS C/ SERRILHA
PONTA TRAVANTE
P/ FORRO DE P.V.C.



PALM	MM	POLEGADA
25801	4,2x13	8x1/2

CABEÇA FLANGEADA
PONTA AGULHA
P/ FORRO DE P.V.C.



CHAPA GALVALUME ECO ROLO



PALM	MTS	LARGURA
29620	25	0,30cm
29631	25	0,40cm
29630	25	0,50cm
29629	25	0,60cm
29628	25	0,70cm
29621	25	0,80cm
29622	25	0,90cm
29626	20	1,00cm

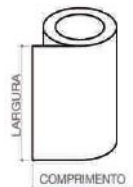

PRODUTOS MAIS USADOS EM VEDAÇÃO DE CALHAS

PALM	PALM	PALM
11775	25953	25948
PU FLEX 280g USO GERAL CINZA	VEDA CALHAS CINZA	SILICONE ACÉTICO MULTIUSO TRANSPARENTE
280g	280g	250ml/240Gr



ESTE PRODUTO NÃO ACEITA SOLDA ELÉTRICA

GANCHO DE REDE ZINCADO



CHAPA PONTA DE LANÇA



CANTONEIRA MÃO FRANCESA



Largura da chapa: 1.1/4 ou (3cm)
Espessura: 1/8 ou (3,17mm)

COD.	TAMANHO/CM
24878	30x20
24879	40x30
24880	50x35



CANTONEIRA PINTADA



CANTONEIRA MÃO FRANCESA

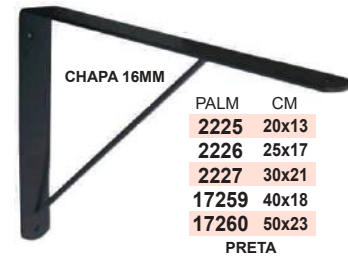
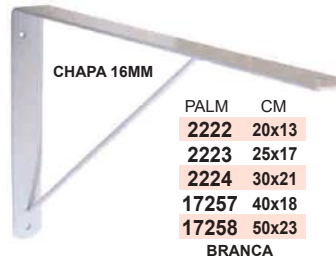

GANCHO ZINCADO P/ PAINEL

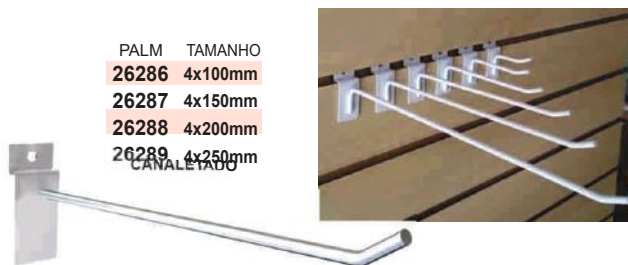

ABRAÇADEIRA

PALM	POL.
1861	3/8x1/2
1862	1/2x5/8
26003	1/2x3/4
26004	9/16x7/8
26005	3/4x1.1/16
BORBOLETA	



ABRAÇADEIRA CLICK

PALM	POL.
18085	3/4"
PRETA	



PALM	POL.
18081	3/4"
CINZA	



POTE C/ ABRAÇADEIRA BORBOLETA

PALM	POL.	QTDE
16614	3/8x1/2	100
16615	1/2x5/8	100
16616	1/2x3/4	100
16617	9/16x7/8	100
16625	3/4x1.1/16	100



POTE ABRAÇADEIRA ROSCA SEM FIM

PALM	MM	POL.	QTDE
16618	9x13	3/8x1/2"	100
16619	12x16	1/2x5/8"	100
16620	14x22	9/16x7/8"	100
16621	19x27	3/4x1"	100
16622	22x32	3/4x1.1/4"	100
16624	25x38	1x1.1/2"	100



MULTI KIT DE ABRAÇADEIRAS



Ideal p/ manutenção em geral,
residências, sítios ou fazendas.



FERRAGENS

UM MIX DE PRODUTOS PARA VOCÊ

ORCA[®]
DISTRIBUIDORA

ABRAÇADEIRA ZINCADA 21mm

PALM	POL.	CM
31143	3/4"	15x20
31144	7/8"	20x25
5795	1"	29x32
31163	1.1/4"	35x40
31183	1.1/2"	39x47

PALM	POL.	CM
31184	1.3/4"	48x56
31203	2"	54x62
31204	2.1/2"	67x75
31205	3"	79x87
31206	4"	99x107

PALM	POL.	CM
31223	3"	79x87
31224	4"	99x107
31225	5"	124x136
31226	6"	149x161

MONGOTÃO

MONGOTINHO



MONGOTINHO



ABRAÇADEIRA P/ MANGUEIRA

PALM	ATÉ
18166	25mm
18167	32mm

BOMBA SUBMERSA

PALM	TAMANHO
17487	6x7
17488	8x9
17489	10x12
17490	12x14

COMBUSTÍVEL/OUTROS

SIMPLES



ABRAÇADEIRA ROSCA SEM FIM - FITA 9MM

PALM	MM	POL.	PALM	MM	POL.
1820	9x13	3/8x1/2"	1828	44x57	1.3/4x2.1/4"
1821	12x16	1/2x5/8"	1829	51x64	2x2.1/2"
1822	14x22	9/16x7/8"	1830	57x76	2.1/2x3"
1823	19x27	3/4x1"	1831	64x83	2.3/4x3.1/4"
1824	22x32	3/4x1.1/4"	1832	70x89	3x3.1/2"
1825	25x38	1x1.1/2"	1833	76x95	3x3.3/4"
1826	32x44	1.1/4x1.3/4"	1834	83x102	3.1/2x4"
1827	38x51	1.1/2x2"	1835	89x108	3.1/2x4.1/4"



9MM

ABRAÇADEIRA ROSCA SEM FIM - FITA 14MM

PALM	MM	POL.	PALM	MM	POL.
1837	14x22	9/16x7/8"	1845	57x76	2.1/2x3"
1838	19x27	3/4x1.1/16"	1846	64x83	2.3/4x3.1/4"
1839	22x32	3/4x1.1/4"	1847	70x89	3x3.1/2"
1840	25x38	1x1.1/2"	1848	76x95	3x3.3/4"
1841	32x44	1.1/4x1.3/4"	1849	83x102	3.1/2x4"
1842	38x51	1.1/2x2"	1850	89x108	3.1/2x4.1/4"
1843	44x57	1.3/4x2.1/4"	1851	102x121	4.1/4x4.3/4"
1844	51x64	2x2.1/2"	1852	114x133	4.1/2x5.1/4"

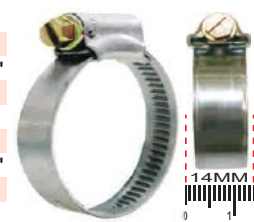

14MM

KIT DE ABRAÇADEIRA ROSCA SEM FIM

ORCA	QTDE	DESCRIÇÃO	POL.
1820	50	ABRAÇADEIRA FITA 9,0mm 9x13	3/8x1/2"
1821	50	ABRAÇADEIRA FITA 9,0mm 12X16	1/2X5/8"
1822	50	ABRAÇADEIRA FITA 9,0mm 14X22	9/16X7/8"
1823	50	ABRAÇADEIRA FITA 9,0mm 19X27	3/4X1"
1824	50	ABRAÇADEIRA FITA 9,0mm 22X32	3/4X1.1/4"
1825	50	ABRAÇADEIRA FITA 9,0mm 25X38	1X1.1/2"
1826	50	ABRAÇADEIRA FITA 9,0mm 32X44	1.1/4X1.3/4"
1827	50	ABRAÇADEIRA FITA 9,0mm 38X51	1.1/2X2"
1819	1	EXPOSITOR DE ABRAÇADEIRAS	-----

COMPOSIÇÃO DO KIT ABRAÇADEIRA 9MM

PALM POL.
1818 100X60
KIT ABRAÇADEIRA C/ 400 PEÇAS

KIT DE ABRAÇADEIRA ROSCA SEM FIM

ORCA	QTDE	DESCRIÇÃO	POL.
1820	50	ABRAÇADEIRA FITA 9mm 9x13	3/8x1/2"
1821	50	ABRAÇADEIRA FITA 9mm 12X16	1/2X5/8"
1837	25	ABRAÇADEIRA FITA 14mm 14X22	9/16X7/8"
1838	25	ABRAÇADEIRA FITA 14mm 19X27	3/4X1"
1839	25	ABRAÇADEIRA FITA 14mm 22X32	3/4X1.1/4"
1840	25	ABRAÇADEIRA FITA 14mm 25X38	1X1.1/2"
1841	25	ABRAÇADEIRA FITA 14mm 32X44	1.1/4X1.3/4"
1842	25	ABRAÇADEIRA FITA 14mm 38X51	1.1/2X2"
1843	25	ABRAÇADEIRA FITA 14mm 44X57	1.3/4X2.1/4"
1844	25	ABRAÇADEIRA FITA 14mm 51X64	2X2.1/2"
1819	1	EXPOSITOR DE ABRAÇADEIRAS	-----

COMPOSIÇÃO DO KIT ABRAÇADEIRA 14MM

PALM POL.
1836 100X60
KIT ABRAÇADEIRA C/ 300 PEÇAS



FOTO ILUSTRATIVA



FOTO ILUSTRATIVA

ROLDANA DE FERRO P/ PORTÃO C/ ROLAMENTO

PALM	POL.	ESP.	PALM	POL.	ESP.	PALM	POL.	ESP.	PALM	POL.	ESP.	PALM	POL.	ESP.
5901	1.1/2	15mm	5907	2"	19mm	28995	2"	15mm	5912	2"	20mm	5917	2"	20mm
5902	2"	19mm	5908	2.1/2	20mm	28996	2.1/2	15mm	5913	2.1/2	20mm	5918	2.1/2	20mm
5903	2.1/2	20mm	5909	3"	20mm	28997	3"	15mm	5914	3"	20mm	5919	3"	20mm
5904	3"	20mm												

C/ PINO

C/ PARAFUSO

C/ PARAFUSO

C/ PINO

C/ PARAFUSO



C/ ROLAMENTO
CAIXA FECHADA
E PINO FURADO
C/ PARAFUSO

CAIXA ABERTA



ROLDANA P/ POÇO

PALM	TAMANHO
5420	8cm
5417	10cm
5418	12cm
5419	14cm



ROLAMENTO GUIA SUPERIOR



PALM	TAMANHO
26678	42x15
26679	48x15

C/ PINO



PALM	TAMANHO
26680	42x15
26681	44x15

C/ ROSCA

RODIZIO STANLEY

PALM	TAMANHO
26682	2x1.1/2

DUPLO

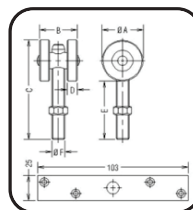

REF	A	B	C	D	E	F
2X1	38	38	93	8,5	55	1/2"

PALM	TAMANHO
26684	2x1.1/2

QUADRUPLA

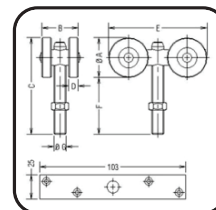

REF	A	B	C	D	E	F	G
4X1	38	38	93	8,5	120	55	1/2"

POLIA DE ALUMÍNIO P/ CORREIA CANAL - A

PALM	CANAL	TAM. (MM/POL.)
9755	1	50mm = 2"
12867	1	70mm = 2.3/4
12866	1	60mm = 2.3/8
9759	1	75mm = 3"
12868	1	80mm = 3.1/8
9796	1	100mm = 4"
12870	1	120mm = 4.3/4
12869	1	110mm = 4.3/8
9798	1	125mm = 5"
12871	1	130mm = 5.1/8
9799	1	150mm = 6"
9760	1	90mm = 3.1/2

1 CANAL



POLIA DE ALUMÍNIO P/ CORREIA CANAL - B

PALM	CANAL	TAM. (MM/POL.)
9845	1	75mm = 3"
9847	1	100mm = 4"

1 CANAL



PALM	CANAL	TAM. (MM/POL.)
9857	2	75mm = 3"
9859	2	100mm = 4"
9863	2	150mm = 6"

2 CANAIS



POLIA DE FERRO FUNDIDO P/ CORREIA CANAL - B

PALM	CANAL	TAM. (MM/POL.)
16917	1	100mm = 3.15/16

1 CANAL



PALM	CANAL	TAM. (MM/POL.)
16928	2	75mm = 2.21/64
16929	2	100mm = 3.15/16
16930	2	125mm = 4.59/64
16931	2	150mm = 5.29/32

2 CANAIS



PALM	CANAL	TAM. (MM/POL.)
9815	2	90mm = 3.1/2
12872	2	115mm = 4.1/2
12874	2	75mm = 3"
9816	2	100mm = 4"
12876	2	125mm = 5"
9812	2	50mm = 2"
12873	2	70mm = 2.3/4
12878	2	140mm = 5.1/2
12877	2	130mm = 5.1/8
9819	2	150mm = 6"

2 CANAIS





— DOBRADIÇA PINTADA TIPO FERRADURA P/ PARAFUSAR — AS MEDIDAS E PESOS PODEM CONTER PEQUENAS VARIÁÇÕES.

Número	Medidas em mm						Medidas em Polegadas		Espessura da Chapa	Peso em Kg
	A	B	C	D	E	F	G	Pino		
0	150	100	50	55	24	15	1/4	5/16	1/8	0,160
1	230	150	65	75	32	20	3/8	1/2	3/16	0,470
2	290	205	85	90	37	25	3/8	5/8	3/16	0,750
3	355	255	100	110	50	30	3/8	5/8	3/16	1,050
4	430	300	130	110	50	30	3/8	5/8	3/16	1,215



— DOBRADIÇA QUADRADA PINTADA P/ PORTEIRA/PORTÃO — AS MEDIDAS E PESOS PODEM CONTER PEQUENAS VARIÁÇÕES.

Número	Medidas em mm			Medidas em Polegadas		Espessura da Chapa	Peso em Kg
	A	B	C	Pino			
0	90	65	1/4	9/16	1/8	0,170	
1	147	75	7/16	7/16	3/16	0,560	
2	175	110	7/16	7/16	3/16	1,040	
3	200	145	7/16	7/16	3/16	1,540	
4	210	160	7/16	1.1/4	3/16	2,100	

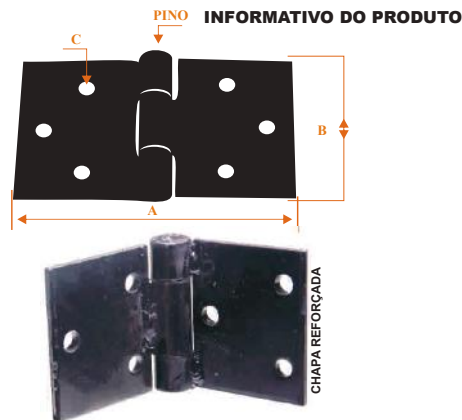

DOBRADIÇA TIPO FERRADURA P/ PARAFUSAR

PALM	Nº	CHAPA
17597	00	1/8
17598	01	3/16
17599	02	3/16
17600	03	3/16
17601	04	3/16



PALM	Nº	CHAPA
7529	00	1/8
7530	01	3/16
7531	02	3/16



PALM	Nº	CHAPA
12774	00	1/8
12087	01	3/16
12088	02	3/16
12089	03	3/16
12093	04	3/16



DOBRADIÇA LEME P/ PORTÃO

PALM	POL.
3804	4"
3805	6"
3806	8"
3807	10"



DOBRADIÇA QUADRADA REFORÇADA P/ PORTEIRA/PORTÃO

PALM	Nº	CHAPA
17592	0	1/8
17593	1	3/16
17594	2	3/16
17595	3	3/16
17596	4	3/16



PALM	CHAPA	Nº
12778	1/8	0
12083	3/16	1
12084	3/16	2
12085	3/16	3
12779	3/16	4



CHAPA EMENDA PINTADA MEIA LUA

PALM	TAMANHO
14870	1.1/2X30cm
14871	1.1/2X35cm
14872	1.1/2X40cm
14874	2X35cm
14875	2X40cm



CHAPA EMENDA PINTADA RETA

PALM	TAMANHO
14866	1.1/2x35cm
14867	1.1/2x40cm
14868	2x40cm
14869	2x50cm



DOBRADIÇA BOCA DE LOBO 3 FUROS (CENTRO)

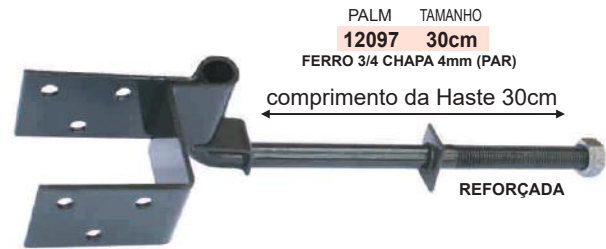

TRANCA SALVA VIDAS PINDADA

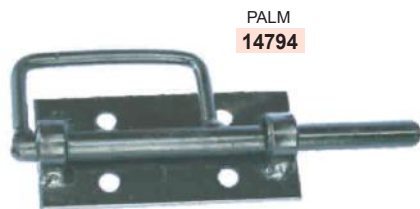

CARABINA FERRO PINTADA



ALICATE GALVANIZADO

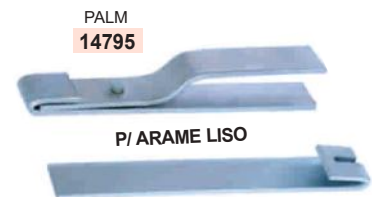

ROLETE PINTADO P/ TRONCO CHAPA 3/16 - PAR



ESTICADOR DE CORDOALHA GALVANIZADO

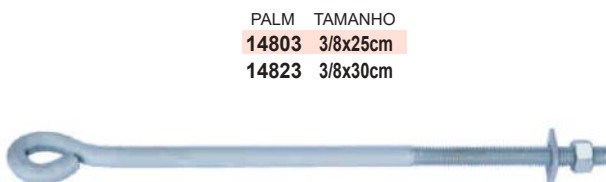

SUPOORTE DE FERRO ZINCADO P/ TRANCA DE PORTAS



ESTRIBO PINTADO



GRAMPO PINTADO

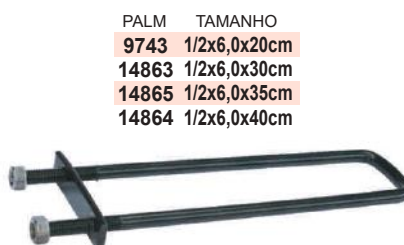

PICOLA FERRO PINTADO





FERRAGENS

UM MIX DE PRODUTOS PARA VOCÊ

ORCA®

DISTRIBUIDORA

LANÇA CHAMAS P13

PALM	REGISTRO	MANGUEIRA
7621	1	1Mts
7622	2	2Mts



ENXÓ CABO DE MADEIRA

PALM	POL.
14849	1"

FORJADO



POTE C/ CLIPS P/ CABO DE AÇO



PALM	POL.	QTDE
16609	1/8"	100
16601	3/16"	100
16611	1/4"	100
16612	5/16"	100
16613	3/8"	100

ESPICHADEIRA PINTADA P/ ARAME LISO



PALM	POL.
14846	7/8

ESTICADOR



PALM	POL.
2285	3/16"
2283	1/4"
2286	5/16"
2284	3/8"
2282	1/2"

P/ CABO DE AÇO

CLIPS P/ CABO DE AÇO

PALM	POL.	PALM	POL.
2273	1/2"	2275	1/8"
2278	5/8"	2280	3/16"
2276	3/4"	2274	1/4"
2279	7/8"	2281	5/16"
2272	1"	2277	3/8"



CHAVE P/ BOB'S

PALM
14796

FERRO MACIÇO GALVANIZADA



BOB'S P/ CERCA

PALM
2520

ZINCADO



ESTICADOR P/ ARAME LISO



PALM
2341

CHAPA DE AÇO ZINCADO

GRAMPO POLIDO

PALM	BITOLA/POL.	QTDEXKILO
7122	7/8x9	244
7121	1x9 P/ CERCA	194



ARAME (KILO)



PALM	Nº	PALM	Nº
24842	12	24846	18
24844	14	24847	20
24845	16		

GALVANIZADO KILO



PALM	Nº
29572	12x2,77
29478	14x2,00
24839	16x1,65
24840	18x1,25

RECOZIDO



PALM	Nº
24841	18x1,25

RECOZIDO TORCIDO



FECHADURA RESIDENCIAL ESPELHO

 PALM 2354 CROMADA EXTERNA BOLA ESPELHO SOPRANO	 PALM 8461 CROMADA EXTERNA COMUM P/ BANHEIRO ESPELHO SOPRANO	 PALM 2353 CROMADA EXTERNA COMUM ESPELHO SOPRANO	 P/ PORTÃO PALM 2352 CROMADA EXTERNA COMUM ESTREITA ESPELHO SOPRANO	MESMA FURAÇÃO DA 601/602 DA STAM COD. 28747 CROMADA SERRALHEIRO ESTREITA 603 ESPELHO INOX PADO	MESMA FURAÇÃO DA 803 DA STAM COD. 28748 CROMADA ZM CONCEPT 401 ESPELHO INOX PADO
--	--	---	--	--	--

FECHADURA STAM (ESPELHO)

 PALM 25269 04 CHAVES TETRA METALON 40X30 INOX 600/03 stam	 PALM 25270 04 CHAVES TETRA GRAFITE 600/03 stam	 PALM 10088 02 CHAVES METALON 40X30 INOX EXTERNA 601/602-03 stam	 PALM 25258 02 CHAVES METALON 40X30 PERFIL METÁLICO GRAFITE EXTERNA 601/602-03 stam	 PALM 25259 02 CHAVES METALON 50X30 PERFIL METÁLICO INOX EXTERNA 501/502-03 stam	 PALM 25260 02 CHAVES METALON 50X30 PERFIL METÁLICO GRAFITE EXTERNA 501/502-03 stam
---	---	--	--	---	--

FECHADURA STAM (ESPELHO)

 PALM 10086 02 CHAVES MADEIRA METALON 70X30 INOX 803/03 ESPELHO stam	 PALM 25262 02 CHAVES GRAFITE EXTERNA stam	 PALM 25266 04 CHAVES TETRA METALON 50X30 INOX 500/011 stam
---	--	--

FECHADURA STAM ROSETA INOX

 METALON 50X30 04 CHAVES TETRA stam PALM 25261 1001	 MADEIRA METALON 70X30 PALM 25265 1004
--	--

FECHADURA STAM ESPELHO

 METALON 50X30 04 CHAVES TETRA stam PALM 25271 INOX (PAR) 1001	 METALON 40X30 PALM 25272 INOX (PAR) 1003
---	--

FECHADURA AUXILIAR STAM ESPELHO

 METALON 40X30 04 CHAVES TETRA stam PALM 10089 INOX - 1003	 METALON 40X30 PALM 25268 GRAFITE - 1003
--	--



FERRAGENS

UM MIX DE PRODUTOS PARA VOCÊ

ORCA®

DISTRIBUIDORA

MAÇANETA



PALM
2439
MAÇANETA ALAVANCA

VISOR OLHO MÁGICO



PALM
17774
REGULÁVEL 35MM A 50MM CROMADO

FECHADURA P/ PORTÃO



PALM HASTE
10095 CURTA
10096 LONGA

P/ GAVETAS C/ CHAVES EMBUTIR



TIPO CAIXÃO C/ CHAVE LISA SOBREPOR

PALM
2343

FECHADURA SOBREPOR REVERSÍVEL PRETA



(ESPELHO) **stam**

COD.
25264
INOX 1701/80
04 CHAVES TETRA



(ESPELHO) **stam**

COD.
10090
INOX 701/80
02 CHAVES SIMPLES



CONCEPT **PADO**

COD. TAMANHO
28749 80mm
28750 100mm

02 CHAVES SIMPLES



FECHADURA STAM ELÉTRICA SOBREPOR



stam

COD.
10091
INOX - 40mm

02 CHAVES SIMPLES



ABERTURA POR DENTRO



PALM
25273
CROMADO



PALM
25267
GRAFITE



PALM MODELO
2359 aliança
2361 soprano
2362 stam

CILINDRO STAM P/ FECHADURA STAM

LONA DE POLIETILENO ENCERADA C/ ILHÓS METÁLICO

PALM	MTS	MICRAS	PALM	MTS	MICRAS
6421	2x2	100	7883	6x3	100
6422	3x2	100	7884	6x4	100
6423	3x3	100	7885	6x5	100
6424	4x3	100	7886	6x6	100
6425	4x4	100	7890	8x4	100
6426	5x3	100	7892	8x6	100
7881	5x4	100	31569	10x5	100
7882	5x5	100	7903	10x8	100

Características:

- *Ilhós feito em alumínio super resistente a cada metro para fixação perfeita;
- *Fio de Polietileno internamente nas laterais, possibilitando uma melhor estruturação de coberturas;
- *Aditivo UV, protege e aumenta a vida da lona quando usada em áreas externas.
- *Laminação dupla com Polietileno trançado internamente, garantindo uma excelente impermeabilização;
- *Resistentes e duráveis, são ideais para: transporte, agricultura, construção, camping e uso doméstico.

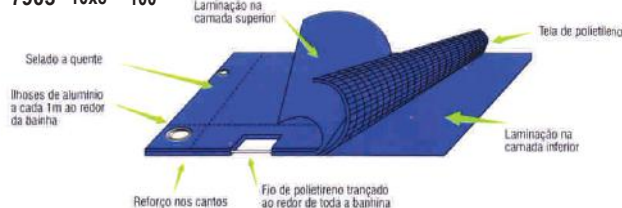

ESPESSURA 100 MICRAS

PALM	MTS	MICRAS	PALM	MTS	MICRAS
28108	2x2	140	28120	7x5	140
28109	3x2	140	28121	7x6	140
28110	3x3	140	28122	8x4	140
28111	4x3	140	28123	8x6	140
28112	4x4	140	28128	9x4	140
28113	5x3	140	28129	9x6	140
28114	5x4	140	28130	10x4	140
28115	5x5	140	28131	10x5	140
28116	6x3	140	28132	10x8	140
28117	6x4	140	28133	12x6	140
28118	6x5	140	28134	12x8	140
28119	6x6	140	28135	15x10	140

Características:

- *Ilhós feito em alumínio super resistente a cada metro para fixação perfeita;
- *Fio de Polietileno internamente nas laterais, possibilitando uma melhor estruturação de coberturas;
- *Aditivo UV, protege e aumenta a vida da lona quando usada em áreas externas.
- *Laminação dupla com Polietileno trançado internamente, garantindo uma excelente impermeabilização;
- *Resistentes e duráveis, são ideais para: transporte, agricultura, construção, camping e uso doméstico.

REFORÇADA



ESPESSURA 140 MICRAS

LONA PRETA AGRO MULTI USO



PALM	MEDIDA	PESO	METRAGEM ²	MICRAS
29635	4x50	10	200	45
29636	4x100	15	400	38
29637	4x100	24	400	60
29638	4x100	30	400	75
29639	4x100	40	400	100
29640	6x50	15	300	50
29641	6x50	27	300	77
29642	6x100	30	600	43
29645	6x100	45	600	75
29646	8x50	21	400	48
29647	8x50	30	400	75
29648	8x50	36	400	90
29649	8x50	50	400	120
29650	8x100	49	800	61
40589	8x100	80	800	100

— LONA PRETA/BRANCA AGRO MULTI USO EXTRA —

PALM	MEDIDA	PESO	METRAGEM ²	MICRAS
31390	4x100	41	400	100
31150	6x100	61	600	100
30538	8x50	41	400	100
29652	8x50	58	400	150
30539	10x50	51	500	100
29653	10x50	72	500	150
29654	12x50	86	600	150



TELA MOSQUITEIRO



PALM	MEDIDA	PESO	METRAGEM ²	COR
29655	1,00x50	3,200	50	VERDE
29656	1,20x50	3,800	60	VERDE
29657	1,50x50	4,700	75	VERDE
29658	1,00x50	3,200	50	CINZA
29659	1,20x50	3,800	60	CINZA
29660	1,50x50	4,700	75	CINZA
29661	1,00x50	3,200	50	BRANCA
29662	1,20x50	3,800	60	BRANCA
29663	1,50x50	4,700	75	BRANCA



TELA TAPUME

PALM	MEDIDA	PESO	METRAGEM ²	COR
29668	1,20x50	3,300	60	LARANJA



TELA DE SOMBREAMENTO

PALM	MEDIDA	PESO	METRAGEM ²	% SOMBRA
29664	1,50x50	5,830	75	50
29665	1,50x50	9,920	75	70
29666	3,00x50	11,450	150	50
29667	3,00x50	20,000	150	70





RODÍZIO CRISTAL GIRATÓRIO LEVE ZINCADO

PALM	TAMANHO
24859	1.1/4
24858	1.5/8

COD			
24859	1.1/4	32	20
24858	1.5/8	41	35
24882	1.5/8	41	35

POL./MM



PALM	TAMANHO
24882	1.5/8



PALM	TAMANHO
24857	1.5/8



1.5/8	41	35
1.5/8	41	35

POL. MM

PALM	TAMANHO
24881	1.5/8



RODÍZIO GEL GIRATÓRIO LEVE ZINCADO

PALM	TAMANHO
19791	1.1/4
8954	1.1/2
19792	1.5/8
26893	2"
17661	3"
17662	4"



PALM	TAMANHO
8953	1.1/2
19793	1.5/8
26894	2"
17664	3"
17666	4"



PALM	TAMANHO
26895	2"
17667	3"
17668	4"



PALM	TAMANHO
26843	2"
17669	3"
17670	4"



RODÍZIO FIXO LEVE ZINCADO

PALM	TAMANHO
26786	2"
26788	3"



PALM	TAMANHO
26743	2"
26764	3"
26783	4"



RODÍZIO GIRATÓRIO LEVE ZINCADO

PALM	TAMANHO
26703	1.1/4
26724	1.5/8
26883	2"
26885	3"
26887	4"
26891	5"

POLIPROPILENO C/ PLACA



PALM	TAMANHO
26884	2"
26886	3"
26888	4"

P.V.C C/ PLACA/FREIO



RODÍZIO GIRATÓRIO LEVE C/ PLACA

PALM	TAMANHO
19794	1.5/8
19795	2"

ZINCADO C/ FREIO



PALM	TAMANHO
26659	1.1/4
19796	2"

ZINCADO S/ FREIO



PALM	TAMANHO
19797	1.1/4

PRETO C/ PINO BUCHA



RODÍZIO GIRATÓRIO LEVE ZINCADO

PALM	TAMANHO
26896	2"
26844	3"

C/ PARAFUSO FREIO



PALM	TAMANHO
26804	2"
26823	3"

C/ PARAFUSO



RODÍZIO PRETO RODA POLIURETANO LARANJA

Produto:

Rodízio com design inovador alinhado com resistência e conforto, fabricado em aço com dupla pista de esferas e acabamento em pintura epóxi preto e roda com núcleo em polipropileno preto e banda em PVC laranja, com duplo rolamento de esferas de precisão, o que melhora significativamente o desempenho do rodízio.

Composição:

Garfo em aço acabamento em pintura eletrostática - Preto
Roda com núcleo em Polipropileno - Preto
Roda de Poliuretano – Cor Laranja
Duplo rolamento – RLS4-2RS
Dureza da roda : 95 SHORE DA
Temperatura de Trabalho: -20°C A 70°C

Piso Indicado:

Concreto liso, asfalto, cerâmica, aço, metal, madeira.
Proteção ao piso, trabalho silencioso, água, contato ocasionado com o vapor, óleo industrial, tração manual.



Especificações

FIXO	GIRATÓRIO	FREIO	POLEGADAS	POLEGADAS	MILÍMETROS	MILÍMETROS	MILÍMETROS	MILÍMETROS	MATERIAL	RODAGEM	Kg
29722	29719	29725	1,5/8	21	24	16	60	✓	5 mm	25	
29723	29720	29726	2	25	28	21	74	✓	5 mm	30	
29724	29721	29727	3	32	40	65	102	✓	10 mm	60	

BEBEDOURO

PALM
29780
GARRAFA PET
P/ AVES



PALM TAMANHO
29778 2L
29779 5L
P/ FRANGO



COMEDOURO TUBULAR

PALM TAMANHO
29781 3Kg
29782 5Kg
29784 15Kg
29785 20Kg
GALVANIZADO
FUNDO PLÁSTICO
P/ AVES



BEBEDOURO PENDULAR

PALM
29786
PLÁSTICO COMPLETO
AUTOMÁTICO
P/ AVES



BEBEDOURO CHUPETA P/ SUÍNO

PALM TAMANHO SUÍNO
29787 PEQUENO INFANTIL
29788 MÉDIO CRECHE
29895 GRANDE ADULTO
LATÃO - P/ SUÍNO



PALM TAMANHO SUÍNO
29896 PEQUENO INFANTIL
29897 MÉDIO CRECHE
29898 GRANDE ADULTO
INOX - P/ SUÍNO



SUPOORTE ADAPTADOR P/ BEBEDOURO SUÍNO

PALM
30147
REDONDO



ALUMÍNIO

PALM
30148
RETO



ALUMÍNIO

PALM
30149
CURVO
45°

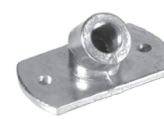

ALUMÍNIO



FERRAGENS

UM MIX
DE PRODUTOS
PARA VOCÊ

ORCA[®]
DISTRIBUIDORA

PULVERIZADOR REGULÁVEL

PALM LITROS
4721 500ml
SPRAY C/ GATILHO
E GARRAFA
TRANSPARENTE



PALM LITROS
28178 500ml
28172 1L
PORTÁTIL,
FÁCIL MANUSEIO



PALM LITROS
24363 1,5L
PRESSÃO ACUMULADA



PALM LITROS
26127 2L
PRESSÃO ACUMULADA



GATILHO
C/ TRAVA

PALM LITROS
28176 1,5L
PRESSÃO ACUMULADA



PALM LITROS
28173 2L
PRESSÃO ACUMULADA

PALM LITROS
28174 5L
PRESSÃO
ACUMULADA



PALM LITROS
24364 5L
PRESSÃO
ACUMULADA



PALM LITROS
28175 7L
PRESSÃO
ACUMULADA



PALM LITROS
24365 8L
PRESSÃO
ACUMULADA



BOMBA PULVERIZADORA 370ml

- * EXTRA FINA E ECONÔMICA;
- * RESISTENTE;
- * PULVERIZAÇÃO EXTRA FINA;
- * PULVERIZADOR MULTI-USO.

PODE SER USADO P/
APLICAÇÃO DE MUITOS
PRODUTOS NA LINHA
AUTOMOTIVA.

ANTIDERRAPANTE

P/ USO DOMÉSTICO E
PROFISSIONAL.
SUBSTITUI O
AEROSOL C/ MAIOR
ECONOMIA E MENOS
CONTAMINAÇÃO.



PALM
2467
LÍQUIDA/INSETICIDA
350ml



PALM
17361
MULTIUSO



PALM LITROS
24443 20L
PRESSÃO ACUMULADA
(COSTAL)



PALM LITROS
28177 20L
PRESSÃO ACUMULADA
(COSTAL)



FIO DE NYLON P/ ROÇADEIRA (ROLO)

PALM TAMANHO
24072 3mmX226M



QUADRADO - LARANJA

PALM TAMANHO
15751 2,7mmX360M
15754 3,0mmX280M



REDONDO - LARANJA

PALM TAMANHO
17251 2,7mmX360M
15755 3,0mmX280M



REDONDO - VERMELHO

PALM TAMANHO
17253 2,7mmX329M



QUADRADO - VERMELHO

FIO DE NYLON P/ ROÇADEIRA

PALM TAMANHO
15746 1,65mmX15M



BLISTER

REDONDO

PALM TAMANHO
15750 2,7mmX15M
15753 3,0mmX15M



BLISTER

REDONDO - VERMELHO

PALM TAMANHO
17255 2,4mmX15M
15748 2,7mmX15M
15752 3,0mmX15M



BLISTER

REDONDO - LARANJA

PALM TAMANHO
15747 1,8mmX670M



ROLO

REDONDO - VERMELHO

FIO DE NYLON BLISTER LARANJA - REDONDO

PALM TAMANHO
25995 2mmX10M



BLISTER

PALM TAMANHO
25996 2,4mmX10M



BLISTER

FIO DE NYLON BLISTER LARANJA - ESTRELA

PALM TAMANHO
25997 2mmX10M



BLISTER

PALM TAMANHO
25998 2,4mmX10M



BLISTER

MACACO HIDRÁULICO (SUPORTA ATÉ 2 TONELADAS)



PALM
24407

Altura: 125mm Curso do pistão: 320mm Base: 42x19,5x13,5cm



MACACO HIDRÁULICO GARRAFA



PALM
24405 2 TONELADA
24406 4 TONELADA
27992 10 TONELADA
30643 15 TONELADA
30644 20 TONELADA



PALM
28272 2 TONELADA
28273 3 TONELADA
28274 4 TONELADA
28275 5 TONELADA
28276 8 TONELADA
28277 10 TONELADA



FERRAGENS

UM MIX DE PRODUTOS PARA VOCÊ

ORCA®

DISTRIBUIDORA

CAMARA DE AR

PALM CM/POL
10137 3,25x8"
P/ CARRINHO DE MÃO

PALM CM/POL
10138 4.10/3.50x8"
P/ CARRINHO DE MÃO

PALM CM/POL
2451 3,25x8"
P/ CARRINHO DE MÃO

PALM CM/POL
23604 400x8"
P/ CARRINHO DE MÃO
CARGA MAX.: 230Kg

LEVORIN



IMPORTADO



LEVORIN



10134

10135

PNEU

PALM CM/POL. LONAS
10136 4.80/4.00x8" 4
PRÓPRIA P/ O USO EM
435Kg

LEVORIN



PALM CM/POL. LONAS
2452 3,25x8" 2
P/ CARRINHO DE MÃO 100Kg

PALM CM/POL. LONAS
23603 4"x8" 4
P/ CARRINHO DE MÃO/
300Kg

PNEUS IMPORTADO



RODA COMPLETA S/ CAMARA 3,25

NÃO FURA, NÃO MURCHA E ABSORVE IMPACTO



PALM
20382
P/ CARRINHO
DE MÃO FURO 1"

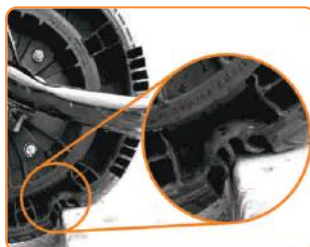

RODA P/ CARRINHO DE MÃO

PALM TAMANHO FURO
8438 4,00x8" 3/4
8439 4,00x8" 1"



REDE ELÁSTICA P/ MOTOCICLETA



PALM TAMANHO
1959 35X35cm
P/ BAGAGEIRO/MOTOCICLETA

ELÁSTICO P/ MOTOCICLETA



PALM MTS
1961 1,5
1962 2,0
1963 3,0
P/ BAGAGEIRO/
MOTOCICLETA

ELÁSTICO P/ BAGAGEIRO



PALM MTS
9653 1,5
9654 2
9655 3
GANCHO METÁLICO



USADO EM VEÍCULOS LEVES



USADO EM LONAS P/ CARRETAS

ELÁSTICO FIXADOR DE LONAS



PALM CM UTILIZAÇÕES
9656 35 CAMINHÃO/CARRETA/BI-TREM
9657 40 CAMINHÕES GRANELEIROS
9658 60 CAMINHÕES/CAÇAMBAS
GANCHO METÁLICO

CORREIAS EM V



CORREIA INDUSTRIAL EM "V" DENTADA
Resistente a óleo e calor. Anti - estática. Atente a norma RMA IP-20



- Largura-topo 1/2 - pol.
Altura 5/16 - pol.

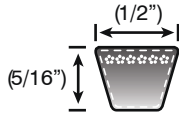

- Largura-topo 21/32 - pol.
Altura 13/32 - pol.

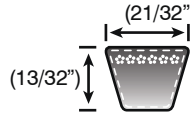

- Largura-topo 7/8 - pol.
Altura 17/32 - pol.

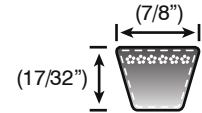

CORREIA TIPO "A"		CORREIA TIPO "A"		CORREIA TIPO "A"		CORREIA TIPO "B"		CORREIA TIPO "B"		CORREIA TIPO "B"		CORREIA TIPO "C"	
PALM	CORREIAS	PALM	CORREIAS	PALM	CORREIAS	PALM	CORREIAS	PALM	CORREIAS	PALM	CORREIAS	PALM	CORREIAS
27677	A-21	27716	A-57	27753	A-92	27842	B-24	27879	B-61	27916	B-96	27924	C-43
27678	A-22	27717	A-58	27754	A-93	27844	B-25	27880	B-62	27917	B-97	27925	C-47
27679	A-23	27718	A-59	27755	A-94	27845	B-26	27881	B-63	27918	B-100	27926	C-51
27680	A-24	27719	A-60	27756	A-95	27846	B-27	27882	B-64	27919	B-105	27927	C-55
27681	A-25	27720	A-61	27757	A-96	27847	B-28	27884	B-65	27920	B-106	27928	C-58
27682	A-26	27721	A-62	27758	A-97	27848	B-29	27885	B-66	27921	B-112	27929	C-60
27685	A-27	27722	A-63	27759	A-98	27849	B-30	27886	B-67	27922	B-113	27930	C-66
27686	A-28	27724	A-64	27760	A-100	27850	B-32	27887	B-68			27931	C-67
27687	A-29	27725	A-65	27761	A-103	27851	B-34	27888	B-69			27932	C-68
27688	A-30	27726	A-66	27762	A-105	27852	B-35	27889	B-70			27933	C-69
27689	A-31	27727	A-67	27765	A-110	27853	B-36	27890	B-71			27934	C-70
27690	A-32	27728	A-68	27766	A-112	27854	B-37	27891	B-72			27935	C-71
27691	A-33	27729	A-69	27767	A-120	27855	B-38	27892	B-73			27936	C-72
27692	A-34	27730	A-70	27768	A-128	27856	B-39	27893	B-74			27937	C-75
27693	A-35	27731	A-71	27769	A-136	27857	B-40	27894	B-75			27938	C-78
27694	A-36	27732	A-72	27770	A-144	27858	B-41	27895	B-76			27939	C-81
27695	A-37	27733	A-73	27771	A-158	27859	B-42	27896	B-77			27940	C-82
27696	A-38	27734	A-74	27772	A-173	27860	B-43	27897	B-78			27941	C-83
27697	A-39	27735	A-75	27773	A-180	27861	B-44	27898	B-79			27942	C-84
27699	A-41	27736	A-76			27862	B-45	27899	B-80			27945	C-85
27700	A-42	27737	A-77			27864	B-46	27900	B-81			27946	C-90
27701	A-43	27738	A-78			27865	B-47	27901	B-82			27947	C-96
27702	A-44	27739	A-79			27866	B-48	27902	B-83			27948	C-100
27704	A-45	27740	A-80			27867	B-49	27904	B-84			27949	C-101
27705	A-46	27741	A-81			27868	B-50	27905	B-85			27950	C-105
27706	A-47	27742	A-82			27869	B-51	27906	B-86			27951	C-111
27707	A-48	27744	A-83			27870	B-52	27907	B-87			27952	C-112
27708	A-49	27745	A-84			27871	B-53	27908	B-88			27953	C-115
27709	A-50	27746	A-85			27872	B-54	27909	B-89			27954	C-120
27710	A-51	27747	A-86			27873	B-55	27910	B-90			27955	C-128
27711	A-52	27748	A-87			27874	B-56	27911	B-91			27956	C-136
27712	A-53	27749	A-88			27875	B-57	27912	B-92			27957	C-144
27713	A-54	27750	A-89			27876	B-58	27913	B-93			27958	C-148
27714	A-55	27751	A-90			27877	B-59	27914	B-94			27959	C-150
27715	A-56	27752	A-91			27878	B-60	27915	B-95			27960	C-158
												27961	C-162
												27962	C-173
												27964	C-180





CORREIAS EM V

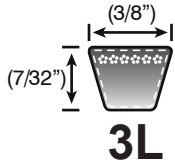

■ Largura-topo 3/8 - pol.
Altura 7/32 - pol.

CORREIA - V JASON PERFIL 3L - 1ª LINHA
Resistente a óleo e calor. Anti - estática. Atente a norma RMA IP-23



PALM	CORREIAS	MARCA/MODELO
28193	3L - 190	CCE DAEWOO/CORE
28195	3L - 210	BRASTEMP/MONDIAL/AGO-95
28196	3L - 220	BRASTEMP/MONDIAL/JUL-95
28197	3L - 230	MULTBRÁS/EXPORTAÇÃO
28200	3L - 260	LATINA/PLENA
28207	3L - 300	ARNOTODAS
28207	3L - 300	SUL-E/LR-60-TOP LOAD 5.0
28208	3L - 310	WESTINGHOUSE/ELETROLUX TP-6
28211	3L - 330	MUELLER/POPTANK/AGO-96-LAVIN
28212	3L - 340	SEMMER/BELLA-EXCENCIAL
28212	3L - 340	FIORETA/TANQUINHO
28214	3L - 360	LAVI-PRACTICK
28214	3L - 360	BRASVITA/SANTAMARIA
28215	3L - 370	DAKO/DAKO WASH
28215	3L - 370	WS/LIVIA-KARINA-JAN-91
28216	3L - 380	LAVI-TANQUINHO/JUL-91
28217	3L - 390	SUGGAR/TANQUINHO
28220	3L - 420	LAVEMAC/LAVEMAC TANQUE
28221	3L - 440	FIORETA/TANQUINHO
28226	3L - 470	LAVEKLO/TANQUINHO
28229	3L - 500	LAVEKLO/MA AZULEJO/JAN-91
28229	3L - 500	FRIGIDAIRE/LAVADORA ARGENTINA
28230	3L - 510	B.S. CONTINENTAL/EVOLUTION (BRASIL)
28239	3L - 590	ENXUTA/EUROMATIC
28248	3L - 670	ENXUTA/SOFT-AURORA

PALM	CORREIAS
28191	3L - 170
28192	3L - 180
28193	3L - 190
28194	3L - 200
28195	3L - 210
28196	3L - 220
28197	3L - 230
28198	3L - 240
28199	3L - 250
28200	3L - 260
28201	3L - 270
28202	3L - 280
28206	3L - 290
28207	3L - 300
28208	3L - 310
28209	3L - 315

PALM	CORREIAS
28210	3L - 320
28211	3L - 330
28212	3L - 340
28213	3L - 350
28214	3L - 360
28215	3L - 370
28216	3L - 380
28217	3L - 390
28218	3L - 400
28219	3L - 410
28220	3L - 420
28254	3L - 430
28221	3L - 440
28222	3L - 450
28225	3L - 460
28226	3L - 470

PALM	CORREIAS
28227	3L - 480
28228	3L - 490
28229	3L - 500
28230	3L - 510
28231	3L - 520
28232	3L - 530
28233	3L - 540
28234	3L - 550
28235	3L - 560
28236	3L - 565
28237	3L - 570
28238	3L - 580
28239	3L - 590
28240	3L - 595
28241	3L - 600
28242	3L - 610

PALM	CORREIAS
28244	3L - 620
28245	3L - 640
28246	3L - 650
28247	3L - 660
28248	3L - 670
28249	3L - 690
28250	3L - 700
28251	3L - 720
28252	3L - 730
28253	3L - 740



CORREIAS EM V

POSSUEM CAPACIDADE MAIS ALTA DE FORÇA. ISTO ELIMINA A FORMAÇÃO DE JOGOS DE CORREIAS C/ SEU MÚLTIPLO PROBLEMAS DE ESTOQUE E DESPÉRDICIO DE CORREIAS. RESISTENTE A ÓLEO E CALOR. ANTI - ESTÁTICA. ATENTE A NORMA RMA IP-22

PALM	CORREIAS
28318	3V - 250
28319	3V - 265
28320	3V - 280
28321	3V - 300
28322	3V - 315
28352	3V - 325
28324	3V - 335
28325	3V - 355
28326	3V - 375
28327	3V - 400
28328	3V - 425
28329	3V - 450
28330	3V - 475
28331	3V - 500
28332	3V - 530
28333	3V - 560
28334	3V - 600
28335	3V - 630
28336	3V - 670
28337	3V - 710
28338	3V - 750
28339	3V - 800
28340	3V - 850
28341	3V - 900
28342	3V - 950
28344	3V - 1000
28345	3V - 1060
28346	3V - 1120
28347	3V - 1180
28348	3V - 1250
28349	3V - 1320
28350	3V - 1400
28351	3V - 1500

PALM	CORREIAS
28353	5V - 500
28354	5V - 530
28355	5V - 560
28356	5V - 600
28357	5V - 630
28358	5V - 670
28359	5V - 710
28360	5V - 750
28361	5V - 800
28362	5V - 850
28364	5V - 900
28365	5V - 950
28366	5V - 1000
28367	5V - 1060
28368	5V - 1120
28369	5V - 1180
28370	5V - 1250
28371	5V - 1320
28372	5V - 1400
28373	5V - 1500
28374	5V - 1600
28375	5V - 1700
28376	5V - 1800
28377	5V - 1900
28378	5V - 2000
28379	5V - 2120
28380	5V - 2240
28381	5V - 2360
28382	5V - 2500
28385	5V - 2650
28386	5V - 2800
28387	5V - 3000

PALM	CORREIAS
28388	8V - 1000
28389	8V - 1060
28390	8V - 1120
28391	8V - 1180
28392	8V - 1250
28393	8V - 1320
28394	8V - 1400
28395	8V - 1500
28396	8V - 1600
28397	8V - 1700
28398	8V - 1800
28399	8V - 1900
28400	8V - 2000
28401	8V - 2120
28402	8V - 2240
28404	8V - 2360
28405	8V - 2400
28406	8V - 2500
28407	8V - 2650
28408	8V - 2800
28409	8V - 3000
28410	8V - 3150
28411	8V - 3350
28412	8V - 3550
28413	8V - 4500

CORREIA INDUSTRIAL EM "V" CLASSE V CONDOR

■ Largura-topo 3/8 - pol.
Altura 5/16 - pol.

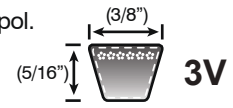

■ Largura-topo 5/8 - pol.
Altura 17/32 - pol.

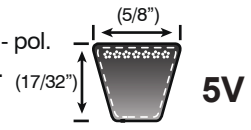

■ Largura-topo 1 - pol.
Altura 7/8 - pol.

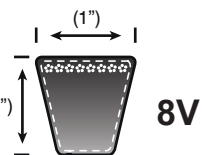



CORREIAS EM V

Correias V - Condor Truematch[®]



**CORREIA DE TRANSMISSÃO
EM "V" TIPO "A"**



**CORREIA DE TRANSMISSÃO
EM "V" TIPO "B"**

PALM	CORREIAS	PALM	CORREIAS	PALM	CORREIAS	PALM	CORREIAS	PALM	CORREIAS	PALM	CORREIAS	PALM	CORREIAS
3339	A-016	3374	A-051	3409	A-086	9993	B-021	3464	B-056	3499	B-091	3534	B-126
3340	A-017	3375	A-052	3410	A-087	3430	B-022	3465	B-057	3500	B-092	16087	B-144
3341	A-018	3376	A-053	3411	A-088	3431	B-023	3466	B-058	3501	B-093	17404	B-130
3342	A-019	3377	A-054	3412	A-089	3432	B-024	3467	B-059	3502	B-094	16085	B-131
3343	A-020	3378	A-055	3413	A-090	3433	B-025	3468	B-060	3503	B-095	9187	B-136
3344	A-021	3379	A-056	3414	A-091	3434	B-026	3469	B-061	3504	B-096	16086	B-140
3345	A-022	3380	A-057	3415	A-092	3435	B-027	3470	B-062	3505	B-097	3535	B-144
3346	A-023	3381	A-058	3416	A-093	3436	B-028	3471	B-063	3506	B-098	9577	B-148
3347	A-024	3382	A-059	3417	A-094	3437	B-029	3472	B-064	3507	B-099	10420	B-150
3348	A-025	3383	A-060	3418	A-095	3438	B-030	3473	B-065	3508	B-100	9188	B-158
3349	A-026	3384	A-061	3419	A-096	3439	B-031	3474	B-066	3509	B-101	9189	B-162
3350	A-027	3385	A-062	3420	A-097	3440	B-032	3475	B-067	3510	B-102	16985	B-173
3351	A-028	3386	A-063	3421	A-098	3441	B-033	3476	B-068	3511	B-103	9190	B-174
3352	A-029	3387	A-064	3422	A-099	3442	B-034	3477	B-069	3512	B-104	23265	B-175
3353	A-030	3388	A-065	3423	A-100	3443	B-035	3478	B-070	3513	B-105	9191	B-178
3354	A-031	3389	A-066	3424	A-104	3444	B-036	3479	B-071	3514	B-106	9192	B-180
3355	A-032	3390	A-067	3425	A-105	3445	B-037	3480	B-072	3515	B-107	10437	B-185
3356	A-033	3391	A-068	16083	A-107	3446	B-038	3481	B-073	3516	B-108	9193	B-195
3357	A-034	3392	A-069	3426	A-111	3447	B-039	3482	B-074	3517	B-109	9194	B-210
3358	A-035	3393	A-070	3427	A-112	3448	B-040	3483	B-075	3518	B-110	9195	B-225
3359	A-036	3394	A-071	3428	A-119	3449	B-041	3484	B-076	3519	B-111	9197	B-249
3360	A-037	3395	A-072	3429	A-120	3450	B-042	3485	B-077	3520	B-112	9196	B-270
3361	A-038	3396	A-073	22959	A-126	3451	B-043	3486	B-078	3521	B-113	9198	B-300
3362	A-039	3397	A-074	22960	A-128	3452	B-044	3487	B-079	3522	B-114		
3363	A-040	3398	A-075	16084	A-136	3453	B-045	3488	B-080	3523	B-115		
3364	A-041	3399	A-076	18140	A-162	3454	B-046	3489	B-081	3524	B-116		
3365	A-042	3400	A-077	9200	A-180	3455	B-047	3490	B-082	3525	B-117		
3366	A-043	3401	A-078			3456	B-048	3491	B-083	3526	B-118		
3367	A-044	3402	A-079			3457	B-049	3492	B-084	3527	B-119		
3368	A-045	3403	A-080			3458	B-050	3493	B-085	3528	B-120		
3369	A-046	3404	A-081			3459	B-051	3494	B-086	3529	B-121		
3370	A-047	3405	A-082			3460	B-052	3495	B-087	3530	B-122		
3371	A-048	3406	A-083			3461	B-053	3496	B-088	3531	B-123		
3372	A-049	3407	A-084			3462	B-054	3497	B-089	3532	B-124		
3373	A-050	3408	A-085			3463	B-055	3498	B-090	3533	B-125		



Resistentes a óleo e calor. Anti-estática

Estas correias possuem capacidade mais alta de força. Isto elimina a formação de jogos de correias com seus múltiplos problemas de estoque e desperdício de correias. Construídas de acordo com a norma RMA IP-22.

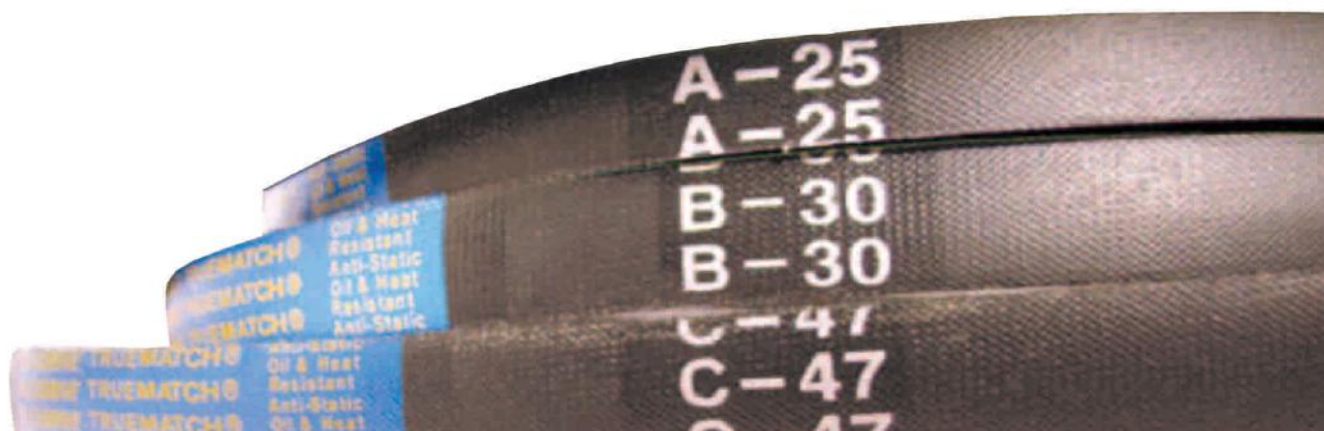



CORREIAS EM V



Correias V - Condor Truematch®



CORREIA DE TRANSMISSÃO EM "V" TIPO "C"

CORREIA DE TRANSMISSÃO EM "V" P/ LAVADORA/TANQUINHO

PALM	CORREIAS	PALM	CORREIAS	PALM	CORREIAS
3536	C-043	3571	C-080	3606	C-115
3537	C-046	3572	C-081	3607	C-116
3538	C-047	3573	C-082	3608	C-117
3539	C-048	3574	C-083	3609	C-118
3540	C-049	3575	C-084	3610	C-119
3541	C-050	3576	C-085	3611	C-120
3542	C-051	3577	C-086	3612	C-122
3543	C-052	3578	C-087	3613	C-123
3544	C-053	3579	C-088	3614	C-124
3545	C-054	3580	C-089	3615	C-125
3546	C-055	3581	C-090	3616	C-126
3547	C-056	3582	C-091	3617	C-127
3548	C-057	3583	C-092	3618	C-128
3549	C-058	3584	C-093	3619	C-129
3550	C-059	3585	C-094	3620	C-130
3551	C-060	3586	C-095	3621	C-131
3552	C-061	3587	C-096	3622	C-132
3553	C-062	3588	C-097	3623	C-133
3554	C-063	3589	C-098	3624	C-134
3555	C-064	3590	C-099	3625	C-135
3556	C-065	3591	C-100	3626	C-136
3557	C-066	3592	C-101	3627	C-137
3558	C-067	3593	C-102	3628	C-138
3559	C-068	3594	C-103	3629	C-139
3560	C-069	3595	C-104	3630	C-140
3561	C-070	3596	C-105	3631	C-151
3562	C-071	3597	C-106	24676	C-162
3563	C-072	3598	C-107	10129	C-170
3564	C-073	3599	C-108	9183	C-172
3565	C-074	3600	C-109	3632	C-180
3566	C-075	3601	C-110	9962	C-210
3567	C-076	3602	C-111	9965	C-225
3568	C-077	3603	C-112		
3569	C-078	3604	C-113		
3570	C-079	3605	C-114		

PALM	DESCRIÇÃO
3635	correia tanquinho colormaq (até dezembro 1990)
3636	correia lavadora eletrolux modelo top. 8
3637	correia tanquinho lavekio modelo mta textura azulejo (até junho 1990)
3638	correia tanquinho lavy (até junho 1991)
3639	correia lavadora mueller modelo nina standard e plus
3640	correia lavadora mueller modelo luxo-2
3641	correia lavadora mueller modelo poptank (até julho 1992)
3642	correia lavadora mueller modelo fibra plus (a partir de abril 1998)
3643	correia lavadora mueller modelo pioneira (a partir de abril 1998)
3644	correia lavadora mueller modelo fibra plus (até março 1998)
3645	correia lavadora mueller modelo luxo - 4
3646	correia lavadora mueller modelo pioneira (até março 1998)
3647	correia lavadora suggar modelo lavamax
3648	correia tanquinho ws modelo karina (até dezembro 1990)
3649	correia tanquinho ws modelo livia (até dezembro 1990)

CORREIA DE TRANSMISSÃO EM "V" P/ MOBILETE - TODAS



PALM	DESCRIÇÃO
3633	MOTOR
3634	RODA

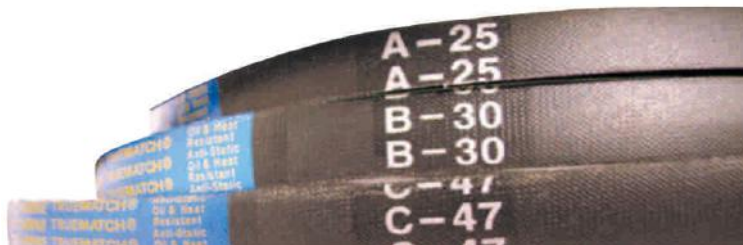

CONJUNTO CINTA DE AMARRAÇÃO



AÇO CARBONO 45
FITA FIBRA DE VIDRO P/
LANCHAS/JET-SKY/CARGAS

PALM	DESCRIÇÃO
24226	25mm - 3 METROS - 800 KILOS
24228	35mm - 6 METROS - 1500 KILOS
24227	50mm - 9 METROS - 1500 KILOS
24229	50mm - 9 METROS - 3000 KILOS
24230	50mm - 9 METROS - 5000 KILOS



25mmX4,5m
AÇO CARBONO 45
FITA FIBRA DE VIDRO
P/ LANCHAS/
P/ JET-SKY/
P/ CARGAS

PALM
26130



CORDA MULTIUSO



PALM	MM/M
21353	6x10
22763	6x15
22923	6X20
22245	6X30



PALM	MM/M
22944	10x10
22765	10X15
22243	10X20
22945	10X30



PALM	MM/M
22766	8x10
22764	8X15
22244	8X20
22943	8X30



CORDA VERDE PET

PALM	MM	MTS	PALM	MM	MTS
3652	4	220	3656	10	165
3653	5	165	3657	12	105
3654	6	150	3658	14	85
3655	8	240	3659	16	95

*** Atenção: Somente vendido em Rolo ***



CORDA BRANCO PET

PALM	MM	MTS
27259	22	220



CORDA POLIESTER TRANÇADA COLORIDA

PALM	MM	CARRETEL	PESO APROXIMADO
3673	3	400 Mts	2.950 kg
3674	4	220 Mts	3.050 kg
3675	5	165 Mts	2.800 kg
3676	6	150 Mts	2.650 kg
3677	8	240 Mts	7.650 kg
3678	10	165 Mts	7.850 kg
3679	12	105 Mts	7.800 kg

EM CARRETEL



KIT DE CORDAS EM CARRETEL

PALM 12363 - KIT DE CORDAS EM CARRETEL 7 ROLOS

PALM	DESCRIÇÃO	QTDE
3650	Expositor de Cordas 4 Andares	1
3652	Corda Verde (PET) Poliéster 4mm	220 MTS
3674	Corda Poliéster Tranç. Color 4mm	220 MTS
3675	Corda Poliéster Tranç. Color 5mm	165 MTS
3676	Corda Poliéster Tranç. Color 6mm	150 MTS
3677	Corda Poliéster Tranç. Color 8mm	240 MTS
3678	Corda Poliéster Tranç. Color 10mm	165 MTS
3679	Corda Poliéster Tranç. Color 12mm	105 MTS

PALM 13323 - KIT DE CORDAS EM CARRETEL 9 ROLOS

PALM	DESCRIÇÃO	QTDE
3650	Expositor de Cordas 4 Andares	1
3673	Corda Poliéster Tranç. Color 3mm	800 MTS
3674	Corda Poliéster Tranç. Color 4mm	220 MTS
3675	Corda Poliéster Tranç. Color 5mm	165 MTS
3676	Corda Poliéster Tranç. Color 6mm	300 MTS
3677	Corda Poliéster Tranç. Color 8mm	240 MTS
3678	Corda Poliéster Tranç. Color 10mm	165 MTS
3679	Corda Poliéster Tranç. Color 12mm	105 MTS

PALM 11121 - KIT DE CORDAS EM CARRETEL 12 ROLOS

PALM	DESCRIÇÃO	QTDE
3650	Expositor de Cordas 4 Andares	1
3674	Corda Poliéster Tranç. Color 4mm	660 MTS
3675	Corda Poliéster Tranç. Color 5mm	495 MTS
3676	Corda Poliéster Tranç. Color 6mm	300 MTS
3677	Corda Poliéster Tranç. Color 8mm	480 MTS
3678	Corda Poliéster Tranç. Color 10mm	165 MTS
3679	Corda Poliéster Tranç. Color 12mm	105 MTS

PALM 8481 - KIT DE CORDAS EM CARRETEL 14 ROLOS

PALM	DESCRIÇÃO	QTDE
3650	Expositor de Cordas 4 Andares	1
3652	Corda Verde (PET) Poliéster 4mm	440 MTS
3674	Corda Poliéster Tranç. Color. 4mm	660 MTS
3675	Corda Poliéster Tranç. Color. 5mm	495 MTS
3676	Corda Poliéster Tranç. Color. 6mm	300 MTS
3677	Corda Poliéster Tranç. Color. 8mm	480 MTS
3678	Corda Poliéster Tranç. Color. 10mm	165 MTS
3679	Corda Poliéster Tranç. Color. 12mm	105 MTS



Possuem alta resistência contra raios ultravioleta, são enzimas para melhorar sua resistência ao atrito. São utilizadas em diversos setores como: selaria, pesca e rodoviário.



KIT DE CORDAS DUPLA ALTO EM CARRETEL

PALM 15650 KIT DE CORDAS EM CARRETEL 21 ROLOS

PALM	DESCRIÇÃO	QTDE
15646	Expositor de Cordas Duplo Alto 5 Andares	1
3673	Corda Poliéster Trançada Colorida 3mm	1600 MTS
3674	Corda Poliéster Trançada Colorida 4mm	660 MTS
3675	Corda Poliéster Trançada Colorida 5mm	495 MTS
3676	Corda Poliéster Trançada Colorida 6mm	450 MTS
3677	Corda Poliéster Trançada Colorida 8mm	720 MTS
3678	Corda Poliéster Trançada Colorida 10mm	495 MTS
3679	Corda Poliéster Trançada Colorida 12mm	210 MTS

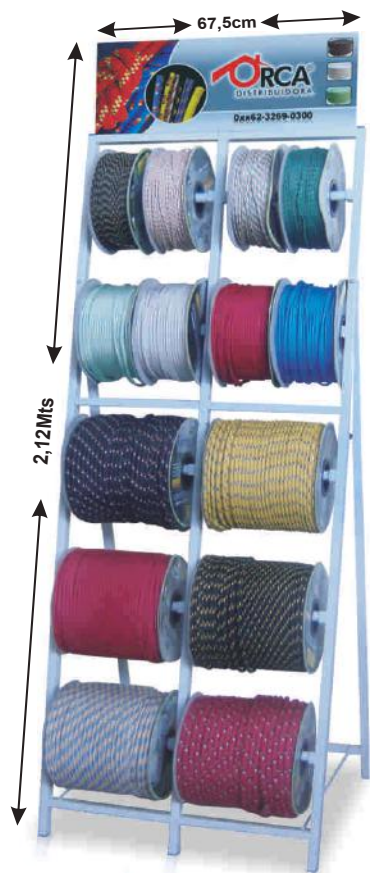

PALM 15649 KIT DE CORDAS EM CARRETEL 14 ROLOS

PALM	DESCRIÇÃO	QTDE
15644	Exp. de Cordas Simp. Alto 5 Andares	1
3673	Corda Poliéster Tranç. Color 3mm	800 MTS
3674	Corda Poliéster Tranç. Color 4mm	440 MTS
3675	Corda Poliéster Tranç. Color 5mm	330 MTS
3676	Corda Poliéster Tranç. Color 6mm	300 MTS
3677	Corda Poliéster Tranç. Color 8mm	480 MTS
3678	Corda Poliéster Tranç. Color 10mm	330 MTS
3679	Corda Poliéster Tranç. Color 12mm	210 MTS

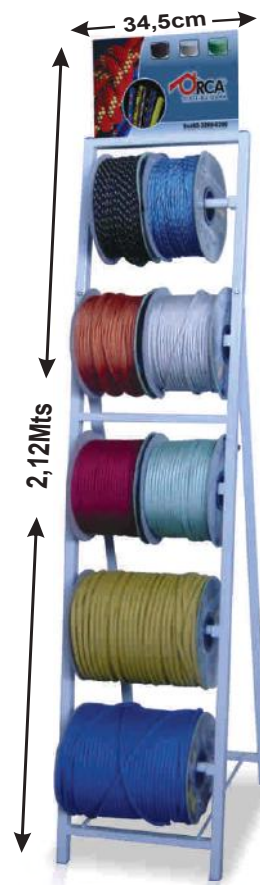

SÃO FABRICADAS 100% EM POLIÉSTER.

Possuem alta resistência contra raios ultravioleta, são enzimadas para melhorar sua resistência ao atrito. São utilizadas em diversos setores como: selaria, pesca e rodoviário.

POTE C/ MIL REBITES REPUXO

PALM	PALM	PALM
16601	16602	16605
3x10	3x12	3x15
1/8x3/8	1/8x1/2	1/8x5/8

ALUMÍNIO - 3



PALM	PALM	PALM
16606	16607	16608
4x10	4x12	4x16
5/32x3/8	5/32x1/2	5/32x5/8

ALUMÍNIO - 4



REBITE REPUXO

PALM	MEDIDAS (MMxPOL.)
1881	3x10 - 1/8x3/8"
1882	3X12 - 1/8X1/2"
1883	3X15 - 1/8X5/8"

ALUMÍNIO - 3



PALM	MEDIDAS (MMxPOL.)
1889	4x10 - 5/32x3/8"
1890	4x12 - 5/32x1/2"
1891	4X16 - 5/32X5/8"

ALUMÍNIO - 4





REBITE REPUXO DE ALUMÍNIO

PALM MEDIDAS (MMxPOL.)

- 1880 3x08 - 1/8x5/16"
- 1881 3x10 - 1/8x3/8"
- 1882 3X12 - 1/8X1/2"
- 1883 3X15 - 1/8X5/8"
- 1884 3X18 - 1/8x3/4"
- 1885 3X20 - 1/8x7/8"

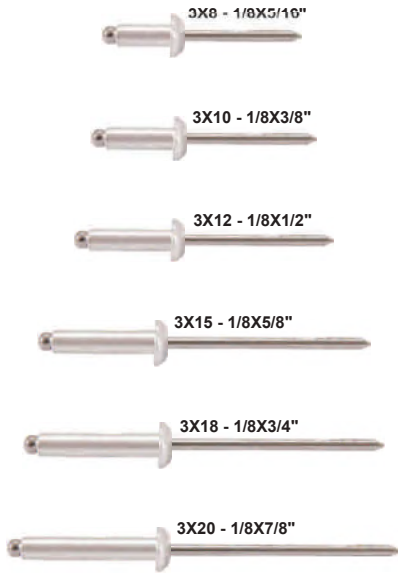

PALM MEDIDAS (MMxPOL.)

- 1888 4x8 - 5/32x5/16"
- 1889 4x10 - 5/32x3/8"
- 1890 4x12 - 5/32x1/2"
- 1891 4X16 - 5/32x3/8"
- 1892 4x18 - 5/32x3/4"
- 1893 4X21 - 5/32x7/8"
- 1894 4x25 - 5/32x1"



PALM MEDIDAS (MMxPOL.)

- 1904 4.8x10 - 3/16x3/8"
- 1905 4.8x12 - 3/16x1/2"
- 1907 4.8X15 - 3/16x5/8"
- 1908 4.8x18 - 3/16x3/4"
- 1909 4.8X22 - 3/16x7/8"
- 1910 4.8x25 - 3/16x1"
- 1911 4.8x30 - 3/16x1.1/4"



REBITE REPUXO DE ALUMÍNIO

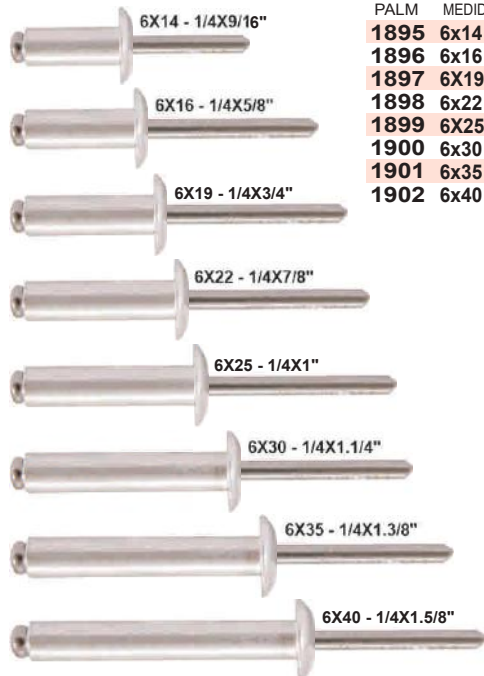

PALM MEDIDAS (MMxPOL.)

- 1895 6x14 - 1/4x9/16"
- 1896 6x16 - 1/4x5/8"
- 1897 6X19 - 1/4x3/4"
- 1898 6x22 - 1/4x7/8"
- 1899 6X25 - 1/4x1"
- 1900 6x30 - 1/4x1.1/4"
- 1901 6x35 - 1/4x1.3/8"
- 1902 6x40 - 1/4x1.5/8"

REBITE REPUXO PRETO

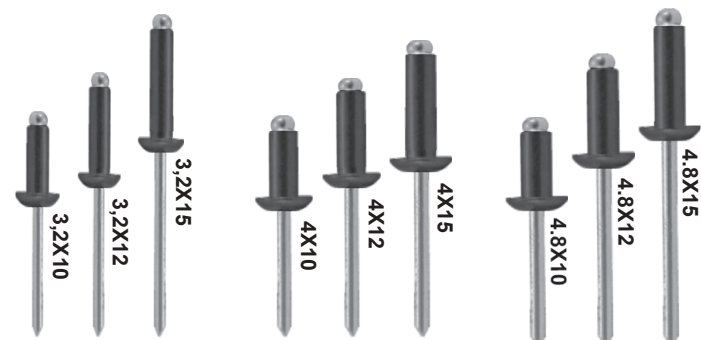

PALM MEDIDAS

- 23098 3,2x10
- 23099 3,2X12
- 23100 3,2X15

ALUMÍNIO - 3

PALM MEDIDAS

- 23101 4x10
- 23102 4x12
- 23103 4X15

ALUMÍNIO - 4

PALM MEDIDAS

- 23104 4.8x10
- 23116 4.8x12
- 23117 4.8X15

ALUMÍNIO - 4.8



REBITE DE REPUXO DE ALUMÍNIO PACOTE C/ 25

PALM	MEDIDA	BITOLA	QTDE
17823	3x6	1/8x1/4	25
17843	3x8	1/8x5/16	25
17863	3x10	1/8x3/8	25
17864	3x12	1/8x1/2	25
17865	3x15	1/8x5/8	25
29104	3x18	1/8x3/4	25
29123	3x20	1/8x7/8	25
17866	4x8		25
17883	4x10	5/32x3/8	25
17884	4x12	5/32x7/16	25
17885	4x15	5/32x9/16	25



PALM	MEDIDA	BITOLA	QTDE
8874	4x18	5/32x11/16	25
10565	4x21	5/32x7/8	25
17903	4x25	5/32x1	25
17923	4,8x10	3/16x3/8	25
17943	4,8x12	3/16x1/2	25
17963	4,8x15	3/16x9/16	25
9975	4,8x18	3/16x11/16	25
9976	6x14	1/4x9/16	25
9976	6x16	1/4x5/8	25
10567	6x19	1/4x3/4	25
10568	6x22	1/4x7/8	25



ESTANTE PRATELEIRA CINZA DE AÇO C/ 6 BANDEJAS

PALM
9338

Atende as mais diversas necessidades de armazenamento, estocagem e exposição de produtos. É perfeita para ser usada em casa, escritório ou estabelecimento comercial!
Totalmente regulável.
Bom acabamento, fácil de montar e funcionalidade ao seu dia a dia.



KIT ENCARTELADO REBITE DE REPUXO

DESCRIÇÃO	QTDE	DESCRIÇÃO	QTDE
EXP. BRANCO P/ PREGOS/DIVERSOS	1	REBITE REP. ALUM. 4x15 (5/32x9/16)	20
REBITE REP. ALUM. 3x6 (1/8x1/4)	25	REBITE REP. ALUM. 4x18 (5/32x11/16)	20
REBITE REP. ALUM. 3x8 (1/8x5/16)	25	REBITE REP. ALUM. 4x25 (5/32x1")	20
REBITE REP. ALUM. 3x10 (1/8x3/8)	25	REBITE REP. ALUM. 6x14 (1/4x9/16)	20
REBITE REP. ALUM. 3x12 (1/8x1/2)	40	REBITE REP. ALUM. 6x16 (1/4x5/8)	20
REBITE REP. ALUM. 3x15 (1/8x5/8)	25	REBITE REP. ALUM. 4,8x10 (3/16x3/8)	20
REBITE REP. ALUM. 3x18 (1/8x3/4)	25	REBITE REP. ALUM. 4,8x12 (3/16x1/2)	20
REBITE REP. ALUM. 3x20 (1/8x7/8)	25	REBITE REP. ALUM. 4,8x15 (3/16x9/16)	20
REBITE REP. ALUM. 4x10 (5/32x3/8)	40	REBITE REP. ALUM. 4,8x18 (3/16x11/16)	20
REBITE REP. ALUM. 4x12 (5/32x7/16)	40		

C/ 18 GANCHEIRAS E 450 SACOLINHAS



HASTE P/ TELHA



PALM	TAMANHO
15863	1/4X250mm
15864	1/4X300mm
15866	1/4X400mm

RETA P/ TELHA

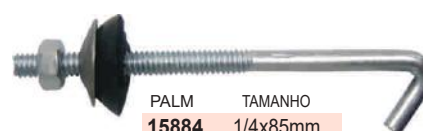

PALM	TAMANHO
15884	1/4x85mm
15885	1/4x100mm
15886	1/4x120mm
15887	1/4x130mm
15888	1/4x150mm

GANCHO P/ TELHA

ARRUELA P/ PREGO/PARAFUSO DE TELHA

PALM	TAMANHO	PALM	TAMANHO
2192	1/4	13184	1/4
	5/16	2190	5/16
MACIA 1/8 P/ PREGO	BORRACHA P/ PARAFUSO	CHAPA METÁLICA P/ PREGO/PARAFUSO	



CONJ. P/ PARAFUSO/PREGO

PALM	ORCA	TAMANHO
13230	2000.374.033	33mm

CHAPA METÁLICA/BORRACHA

PACOTE DE PREGO P/ TELHA

C/ VEDAÇÃO DE BORRACHA - 500GrS

PALM	TAMANHO
2784	19X27

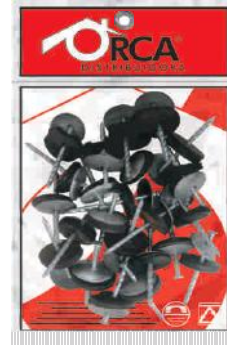

PARAFUSO SEXTAVADO AUTO PERFORANTE C/ ASA PONTA AGULHA



PALM	TAMANHO
27132	5,0X110mm

C/ ARRUELA DE
VEDAÇÃO MÓVEL

PARAFUSO P/ TELHA AMIANTO

PALM	TAMANHO
2505	5/16X110mm
15843	5/16X130mm
15844	5/16X150mm

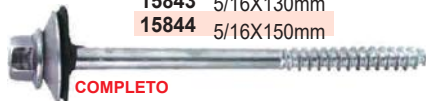

PARAFUSO P/ TELHA AMIANTO

PALM	TAMANHO
35280	5/16X110mm



PALM	TAMANHO
35876	5/16X110mm



PREGO POLIDO C/ CABEÇA

PALM	BITOLA	TAMANHO (MM.)	TAMANHO (POL.)
6501	8X8	1,30X18	
6521	10X10	1,40X21	7/8X17
6481	12X12	1,80X28	
6541	13X15	2,00X34	1.1/4X15
6542	13X18	2,00X41	1.1/2X15
6561	14X15	2,20X34	1.1/4X14
6650	14X18	2,20X41	1.1/4X14
6601	15X15	2,20X34	1.1/4X13
6602	15X21	2,40X48	2X12
6621	16X21	2,70X48	2X13
6622	16X24	2,70X55	2.1/4X12
6623	17X21	3,00X48	2X11
6641	17X27	3,00X62	2.1/2X11
6661	18X21	3,40X48	2X10
6651	18X24	3,40X55	2.1/4X10
6642	18X27	3,40X62	2.1/2X10
6647	18X30	3,90X69	2.3/4X10
6648	19X36	3,90X83	3.1/4X9
6649	20X30	4,40X69	2.3/4X7



KIT DE PREGOS POLIDO C/ CABEÇA

PALM
2766

COMPOSIÇÃO C/ 100 GRAMAS
E 450 SACOLINHAS

MARCA	BITOLA	QTDE	TAMANHO (MM.)
Gerdau/Triângulo	8X8	20	1,30X18
Gerdau/Triângulo	10X10	30	1,50X23
Gerdau/Triângulo	12X12	30	1,80X28
Gerdau/Triângulo	13X15	30	2,00X34
Gerdau/Triângulo	13X18	40	2,00X41
Gerdau/Triângulo	14X18	40	2,20X41
Gerdau/Triângulo	15X15	50	2,40X34
Gerdau/Triângulo	15X21	30	2,40X48
Gerdau/Triângulo	16X21	30	2,70X48
Gerdau/Triângulo	17X21	30	3,00X48
Gerdau/Triângulo	17X27	30	3,00X62
Gerdau/Triângulo	18X24	30	3,40X55
Gerdau/Triângulo	18X27	20	3,40X62
Gerdau/Triângulo	18X30	20	3,40X69
Gerdau/Triângulo	19X36	20	3,90X83
Gerdau/Triângulo	20X30	10	4,40X69



PREGO POLIDO C/ CABEÇA

POCOTE C/ 100 GRAMAS

PALM	BITOLA	QTDE	TAM. (MM.)	TAM. (POL.)
2767	8X8	494	1,30X18	
2768	10X10	325	1,50X23	7/8X17
2769	12X12	164	1,80X28	
2770	13X15	107	2,00X34	1.1/4X15
2771	13X18	93	2,00X41	1.1/2X15
2772	14X18	71	2,20X41	1.1/4X14
2773	15X15	68	2,40X34	1.1/4X13
2774	15X21	48	2,40X48	2X12

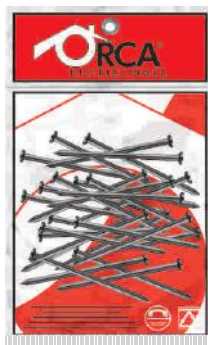

POCOTE C/ 100 GRAMAS

PALM	BITOLA	QTDE	TAM. (MM.)	TAM. (POL.)
2775	16X21	40	2,70X48	2X13
2776	17X21	30	3,00X48	2X11
2777	17X27	24	3,00X62	2.1/2X11
2778	18X24	23	3,40X55	2.1/4X10
2779	18X27	20	3,40X62	2.1/2X10
2780	18X30	19	3,40X69	2.3/4X10
2781	19X36	12	3,90X83	3.1/4X9
2782	20X30	10	4,40X69	2.3/4X7

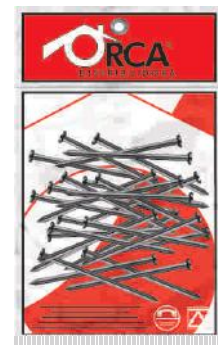



FERRAGENS

UM MIX DE PRODUTOS PARA VOCÊ

ORCA®

DISTRIBUIDORA

CORRENTES SOLDADAS GALVANIZADAS

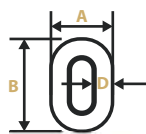

PALM	DIÂMETRO DOS ELOS	ELOS AXBmm	PESO kg/m	TRABALHO kgf	RUPTURA kgf	PESO EMB.	METRAGEM APROXIMADA
28080	3,0mm	27x13	0,216	200	400	12,5	55,88
28081	4,0mm	31x15	0,299	300	550	12,5	41,80
28082	5,0mm	36x19	0,506	400	700	12,5	24,75
28084	6,0mm	39x22	0,731	700	1400	25,0	34,20
28085	8,0mm	51x30	1,163	1200	2300	25,0	21,50
28086	9,5mm	50x34	1,812	1700	3100	25,0	13,80
28087	12mm	72x43	2,550	3000	5800	50,0	19,60

MULTIUSO DISPONÍVEL EM VÁRIAS MEDIDAS

CORRENTE P/ CALHA



PALM	MM	MTS
14293	1,25	20

ELO S/ SOLDA ZINCADA



CORRENTE ZINCADA

PALM	CM
2320	40

C/ ARGOLAS P/ CADEADO



PALM	CM
2321	70

Nº 1 C/ GANCHO P/ REDE



PALM	Nº	PALM	Nº	PALM	Nº
2322	0	2326	4	2326	4
2323	1	2327	5	2327	5
2324	2	2328	6	2328	6
2325	3	2329	7	2329	7



MOSQUETÃO

PALM	Nº	MM
2443	3	130

C/ ARGOLA



COLEIRA P/ CACHORRO

PALM	COSTURA	PALM	COSTURA
2287	0	2292	5
2288	1	2293	6
2289	2	2294	7
2290	3	2295	8
2291	4		



TRAVA P/ MOTO (CHAVE C/ LED)



PALM	TAMANHO
4086	22x1,0

TRAVA P/ BICICLETA



PALM
2358

C/ CHAVE 8mm 60cm

VELA DE IGNIÇÃO

PALM	TAMANHO
16228	CURTA

L7T MOTO SERRA/ ROÇADEIRA



PALM	TAMANHO
16227	LONGA

E6C MOTO SERRA/ ROÇADEIRA



VELA DE IGNIÇÃO UNIVERSAL

PALM
16229

P/ MOTOR ESTACIONÁRIO ROÇADEIRA/MOTOSERRA (F6RTC)



CACHIMBO DE VELA

PALM
15510

CACHIMBO DE VELA P/ ST 038/380/381/051 HUSQVARNA PEQUENO



TUBO DE COBRE S/ COSTURA, FLEXÍVEL E RECOZIDO



PALM	POL.	METROxKG
11081	3/16	11,50Mts x kg
11061	1/4	8,50Mts x kg
11101	5/16	6,60Mts x kg
11083	3/8	5,00Mts x kg
11082	1/2	4,20Mts x kg

UTILIZADO EM: AR CONDICIONADO, REFRIGERAÇÃO, CANO DE FREIO, ETC... Norma: ASTM B-743

FUNIL PRETO PLÁSTICO

PALM
5360

FLEXÍVEL



SUPOORTE P/ ANTENA DE TV



PALM	DESCRIÇÃO
26263	1" - 10cm CAVALETE
8691	3/4" - 10cm CAVALETE
8696	1" - 30cm CAVALETE
8695	3/4" - 30cm CAVALETE

PALM	PAREDE
26244	1" - DUPLA
8692	3/4" - DUPLA



PALM	PAREDE
26223	1" - SIMPLES



NÚMERO RESIDENCIAL DE PLÁSTICO NA COR BRONZE

PALM	NÚMERO
7305	"0"

PALM	NÚMERO
7306	"1"

PALM	NÚMERO
7307	"2"

PALM	NÚMERO
7308	"3"

PALM	NÚMERO
7309	"4"

PALM	NÚMERO
7310	"5"

PALM	NÚMERO
7311	"6" / "9"

PALM	NÚMERO
7312	"7"

PALM	NÚMERO
7313	"8"



VARÃO DE ALUMÍNIO REVESTIDO EM PVC P/ CORTINA

PALM	MM	CORES
6163	1,5	TABACO
6166	2,0	TABACO
6172	3,0	TABACO



Tabaco

PALM	MM	CORES
6162	1,5	BRANCO
6165	2,0	BRANCO
6168	2,5	BRANCO
6171	3,0	BRANCO



Branco

PALM	MM	CORES
6161	1,5	MARFIM
6164	2,0	MARFIM
6167	2,5	MARFIM
6170	3,0	MARFIM



Marfim

CANTONEIRA (PAT'S 'L')



PALM	DESCRIÇÃO
2229	C/ PARAFUSO P/ TRILHO DE CORTINA

RODÍZIO



PALM	DESCRIÇÃO
2231	P/ TRILHO DE CORTINA

CABO DE MADEIRA ROSCAVEL P/ VASSOURAS/RODOS/ANCINHOS

LIXADO COM ACABAMENTO NATURAL!



ROSCA NA EXTREMIDADE

PALM	CM
26001	119x2

VASSOURÃO C/ CABO

LIMPEZA EXTERNA CORPO EM PLÁSTICO EXCELENTE QUALIDADE E DURABILIDADE



PALM	CM	DESCRIÇÃO
5438	37	P/ GRAMA (MAX)



PALM	CM	DESCRIÇÃO
13093	40	P/ GARI REFORÇADA (NYLON)



FERRAGENS

UM MIX
DE PRODUTOS
PARA VOCÊ

ORCA®

DISTRIBUIDORA

VEDANTE DE ALUMÍNIO P/ PORTA

PALM	PALM	PALM
7861	7862	7863
80cm	90cm	100cm



CABO DE AÇO REVESTIDO P/ VARAL

PALM	TAMANHO	PALM	TAMANHO	PALM	TAMANHO
2198	10Mts	2199	15Mts	2200	20Mts



KIT CORDÃO P/ CADEIRA RECICLADO

*** COLOCAR AO SOL DESENROLADO P/ UM MAIOR APROVEITAMENTO ***

PALM			
2298			
KIT - UMA COR DE CADA			
PALM	CORES	PALM	CORES
2299	AMARELO	2305	LILÁS
2300	AZUL	2306	PRATA
2301	BRANCO	2308	VERDE
2303	LARANJA	2309	VERMELHO
2304	ROXO		



Rolo c/ 1 Kilo = +- 40 a 50Mts

KIT CORDÃO P/ CADEIRA MAT. VIRGEM

*** COLOCAR AO SOL DESENROLADO P/ UM MAIOR APROVEITAMENTO ***

MATERIAL VIRGEM

PALM	CORES
2510	AZUL
2518	VERDE
2519	VERMELHO



Rolo c/ 1 Kilo = +- 40 a 50Mts

ETIQUETADORA P/ PREÇOS



PALM
2133

MÁQUINA DE FITA ADESIVA



PALM
24430
EMPACOTADORA

DESENTUPIDOR MANUAL P/ TUBULAÇÃO

UTILIZADO P/ DESOBSTRUIR PIAS, LAVATÓRIOS, RALOS, TANQUES, SAÍDA DE LAVADOURA E TUBULAÇÕES EM GERAL

PALM
26074
5 Mts - 5 mm

PALM
26072
7 Mts - 5 mm



CALCULADORA ELETRÔNICA



PALM
21769
12 DÍGITOS
ELETRÔNICA
CLASSE 6235



PALM
12841
8 DÍGITOS
ELETRÔNICA

SUPORE PRETO TRI-ARTICULADO P/ FIXAÇÃO DE TV

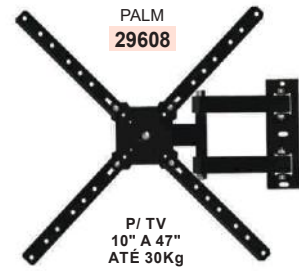
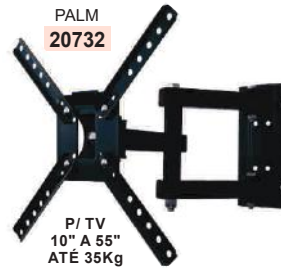

SUPORE PRETO BI-ARTICULADO P/ FIXAÇÃO DE TV



SUPORE UNIVERSAL P/ TV



KIT PARAFUSO



SUPORE P/ FIXAÇÃO DE TV



SUPORE P/ FIXAÇÃO



SUPORE P/ CONDENSADORA DE AR

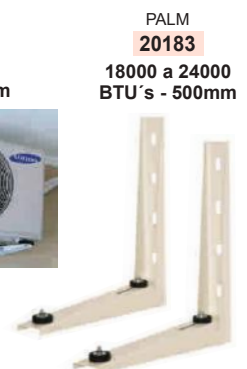
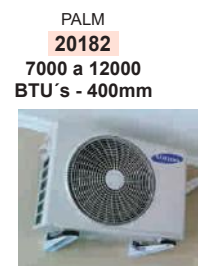

TRILHO PERFORADO PRATELEIRA BRANCO

PALM 26742 50cm	PALM 26744 1,0MT	PALM 26745 1,5MT	PALM 26746 2,0MT
------------------------------	-------------------------------	-------------------------------	-------------------------------



SUPORE SIMPLES P/ TRILHO PRATELEIRA

PERFORADO - BRANCO 25cm		
PALM 26748 1,0 KG	PALM 26747 1,5 KG	PALM 26749 2,0 KG

FITA ADESIVA METALIZADA



UTILIZADA EM
AR CONDICIONADO



KIT EXPOSITOR MANTA TÉRMICA



8 ROLOS DE MANTAS E 10 ROLOS DE FITAS P/ EMENDA

PALM
12373

KIT SIMPLES 1 FACE

PALM	TAMANHO	QTDE
12290	EXPOSITOR P/ MANTAS TÉRMICA GRANDE P/ 4 ROLOS	1
12098	MANTA TÉRMICA SIMPLES 1 FACE 10m2 1,15mX8,70mX0,27mm	3
12099	MANTA TÉRMICA SIMPLES 1 FACE 25m2 1,15mX21,74mX0,27mm	3
12100	MANTA TÉRMICA SIMPLES 1 FACE 50m2 1,15mX43,70mX0,27mm	2
12105	FITA ADESIVA ALUMINIZADA 48mmX50Mts	10

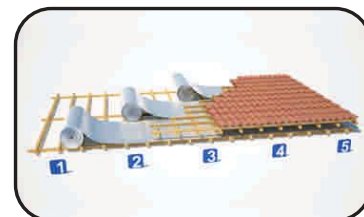

PALM
12372
KIT DUPLO 2 FACES

PALM	TAMANHO	QTDE
12290	EXPOSITOR P/ MANTAS TÉRMICA GRANDE P/ 4 ROLOS	1
12101	MANTA TÉRMICA DUPLA 2 FACES 10m2 1,15mX8,70mX0,28mm	3
12102	MANTA TÉRMICA DUPLA 2 FACES 25m2 1,15mX21,74mX0,28mm	3
12104	MANTA TÉRMICA DUPLA 2 FACES 50m2 1,15mX43,70mX0,28mm	2
12405	FITA ADESIVA ALUMINIZADA 48mmX50Mts	10

MANTA TÉRMICA



PALM	TAMANHO
12098	10M² 1,15mX08,70mX0,27mm
12099	25M² 1,15mX21,74mX0,27mm
12100	50M² 1,15mX43,70mX0,27mm

MANTA SIMPLES 1 FACE TÉRMICA

PALM	TAMANHO
12102	25M² 1,15mX21,74mX0,28mm
12104	50M² 1,15mX43,70mX0,28mm

MANTA DUPLA 2 FACES TÉRMICA

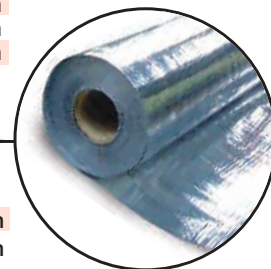

BETUME ASFÁLTICO

APLICAÇÃO

COMPOSTO DE ASFALTO MODIFICADO E ELASTÔMERO, PROPORCIONANDO UMA EXCELENTE ADERÊNCIA, UTILIZADO COMO MATÉRIA-PRIMA EM INDÚSTRIA DE TINTAS. FUNÇÕES: ESCURECEDOR DE VERNIZES, RESINA EM FORMULAÇÕES DE PRETO-CHASSIS E AGENTE AGLOMERANTE EM COMPOSIÇÃO DE PASTAS TIPO "BATE-PEDRA" NA INDÚSTRIA AUTOMOBILÍSTICA.



PALM
22883
15kg +/-

USADO EM CÂMARAS FRIGORÍFICAS, ESTACIONAMENTO, JUNTAS E SAUNAS.

FITA AUTO ADESIVA TÉRMICA ALUMINIZADA

APLICAÇÃO

A BASE DE ASFALTO. É UMA MASSA SELANTE E AUTO-PROTEGIDA POR UMA LÂMINA DE ALUMÍNIO MACIO. É RESISTENTE E DURÁVEL. USO DOMÉSTICO E INDUSTRIAL. APLICA-SE A FRIO E MANUALMENTE SOBRE SUPERFÍCIES LIMPAS E SECAS, ISENTAS DE PÓ E DE OLEOSIDADE.

PALM	TAMANHO
30120	1,00mmX05cmX10mts
26643	1,00mmX10cmX10mts
26663	1,00mmX15cmX10mts
26683	1,00mmX20cmX10mts
10490	1,00mmX30cmX10mts
30121	1,00mmX45cmX10mts
30122	1,00mmX60cmX10mts
30126	1,00mmX100cmX10mts



REMENDA / UNE / VEDA / COLA / REPARA



FITA CREPE P/ EMBALAGEM

PALM MM/M
17783 48mmX50m
EXTRA LARGA



PALM MM/M
2406 19mmX50m
2407 25mmX50m



PALM MM/M
26986 18mmX40m
26987 24mmX40m
26988 48mmX40m
NORTON CLASSIC



PALM MM/M
26873 18mmX50m
26874 24mmX50m
26875 48mmX50m
USO GERAL NORTON



FITA MULTI-USO

PALM MM/M
25101 48mmx50m
CINZA TIPO SILVERTAPE



PALM
18638
5369 AMARELA
12mmX20Mts

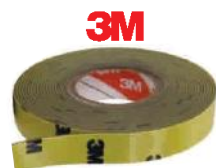

PALM
18718
4910 VERDE FLOW
12mmX20Mts



PALM MM/M
26876 12mmX3m
26877 19mmX3m
26878 25mmX3m
TRANSPARENTE VERDE



PALM MM/M
26123 19mmX2m
VERDE



FITA P/ EMBALAGEM

PALM MTS
2409 45
MARRON



PALM MTS
2410 45
TRANSPARENTE



PALM MTS
26124 48mmX50m
ADESIVA FRÁGIL



FITILHO RAFIA MÉDIO

PALM G
2411 900
P/ AMARRAÇÃO



PERCEVEJO LATONADO

PALM TAMANHO
2448 80
2449 90
2450 100

P/ ESTOFADOS E
TAPECEIRO EM GERAL



PALM
2447
CX C/ 100
P/ USO GERAL



PALM
26089
C/ 100 PEÇAS
NIQUELADO



PALM
26088
C/ 100 PEÇAS
LATONADO



TACHINHA AZULADA

PALM NÚMERO
2487 6
2488 8
2489 10
2490 12
2491 14
CX C/ 100





BALANÇA ELETRÔNICA DE VIDRO P/ BANHEIRO



Liga com um toque/visor de cristal líquido
Indicador de nível da bateria

Especificações:
Capacidade máxima: 150 kg/
Acompanha: 1 bateria de lítio
Desligamento: Automático/6mm

PALM REF.
24431 150Kg
QUADRADA



BOTÃO (KG | OFF | LB)

PALM REF.
26031 180Kg
REDONDA 33cmX6mm

Liga/Desliga Automaticamente
vidro temperado, Visor 4 Dígitos
Fonte de Energia bateria
Espessura 6mm

BALANÇA DIGITAL DE COZINHA



PALM
26032

10 kg

Corpo em Plástico
Gradação - 1 g
Sistema de tara
Função para pesar em gramas ou onça (OZ)
Desliga automaticamente após o uso

PILHAS NÃO INCLuíDAS
COR: BRANCA

BALANÇA DIGITAL P/ PEIXE

PALM KILO
20405 40Kg



GATILHO SPRAY P/ GARRAFA PET



PALM
26126
KIT C/ 10 PEÇAS
TUBO 24CM



BALANÇA MANUAL P/ PEIXE

PALM KILO
26033 12Kg



PALM KILO
24408 25Kg
24423 50Kg



PALM KILO
26034 100Kg

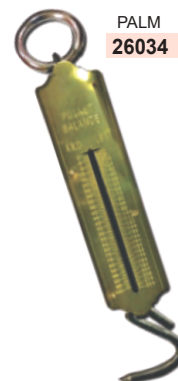

PULVERIZADOR P/ USO EM GARRAFA PET

UTILIZADO EM JARDINS, CONTROLE DE PRAGAS,
LAVAGEM DE CARRO E OUTROS



JATO
REGULÁVEL

PRESSIONE
PARA LIBERAR
A PRESSÃO

PALM
25945
MATERIAL PP
28,5cm / 72g



ENCAIXA IDEAL P/ GARRAFA PET

— **AMASSADOR DE LATAS** —

PALM TAMANHO
26035 33cm
P/ LATAS 350ml
CORPO EM AÇO
PUNHO C/ ESPONJA
(ACOMPANHA PARAFUSOS)



C/
ABRIDOR
DE
GARRAFAS

— **MOEDOR DE CARNES MANUAL** —



PUNHO
EM MADEIRA



PERFURAÇÃO DO
DISCO: 8mm



ACOMPANHA DISCO
PERFURADO E LÂMINA
DE CORTE



DESMONTÁVEL

PALM TAMANHO
26067 25x9,5x25cm
CHAPA Nº 8 DISCO 8MM
1,9Kg - FERRO FUNDIDO
(PINTURA SPRAY)

PALM TAMANHO
26068 27x11x26,5cm
CHAPA Nº 10 DISCO 12MM
2,2Kg - FERRO FUNDIDO
(PINTURA SPRAY)

— **MOEDOR MANUAL DE GRÃOS/CEREAIS** —



PUNHO
EM MADEIRA



FUNIL COM
PINTURA NIQUELADA



UTILIZADO EM DIVERSOS
TIPOS DE GRÃOS

FIXADOR
DE MESA

PALM TAMANHO
26066 35x13,5x37cm
CAPACIDADE 0,7L - 3,3Kg
FERRO FUNDIDO
(PINTURA SPRAY)
DESMONTÁVEL

— **DESCASCADOR MANUAL DE LARANJAS** —



O Descascador tem toda
a sua estrutura
construída em Metal



PALM TAMANHO
26062 25,5x8x15,8cm
LÂMINA AÇO INOXIDÁVEL
EIXO AÇO CARBONO NIQUELADO
CABO PLÁSTICO

— **ABRIDOR DE GARRAFAS** —

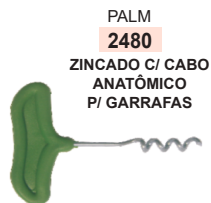

PALM
2480
ZINCADO C/ CABO
ANATÔMICO
P/ GARRAFAS



PALM
2186
P/ GARRAFAS



PALM
2187
P/ GARRAFAS/LATAS

— **AGULHA P/ CHAMA DE FOGÃO** —



PALM
2508
CARTELA C/ 2 PEÇAS

— **FURADOR DE CÔCO** —



PALM
26075
CORPO
EM AÇO E PP

— **AFIADOR DE FACAS E LAMINAS EM GERAL** —



VENTOSA PARA FIXAÇÃO NA BASE
ABAIXE/ LEVANTE A ALÇA PARA ACIONAR
A VENTOSA E PRENDER NA SUPERFÍCIE

PALM TAMANHO
26069 5,9x6,2cm
UTILIZADO P/ AFIAR
FACAS/ TESOURAS/CANIVETES
E LÂMINAS EM GERAL





FERRAGENS

UM MIX DE PRODUTOS PARA VOCÊ

ORCA[®]
DISTRIBUIDORA

COADOR

PALM	MEDIDA
2130	pequena
2131	média
2132	grande



PILÃO C/ SOCADOR

PALM	MEDIDA
2097	grande

P/ ALHO/CAIPIRINHA



TÁBUA P/ CORTE



VELA P/ FILTRO DE BARRO

PALM	ESPECIFICAÇÃO
2128	comum
2129	carvão ativado



CHAVE P/ REGULADOR DE GÁS

PALM
2412



MANGUEIRA

PALM
2477

P/ REGULADOR DE GÁS 1,20 METROS



REGULADOR

PALM
2478

VINIGÁS
regulador para gás
P/ BOTTÃO DE GÁS



REGULADOR P/ BOTTÃO DE GÁS ALIANÇA

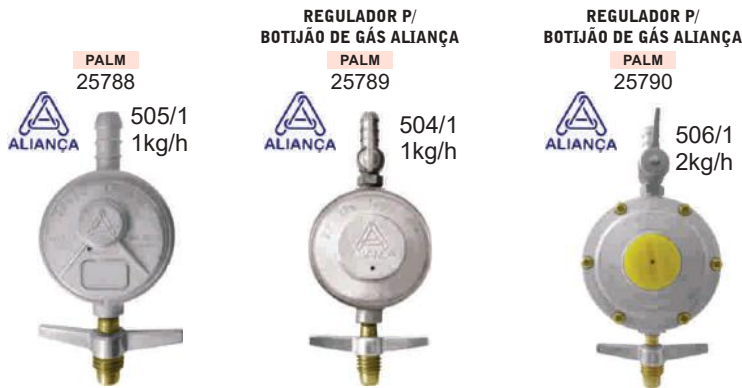

KIT REGULADOR DE GÁS



BORRACHA P/ PAINEL DE PRESSÃO

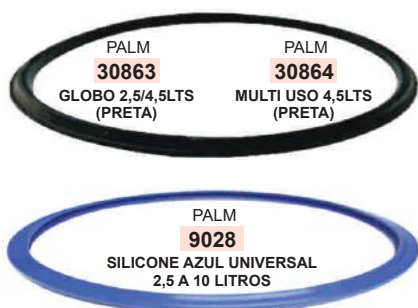

CONJUNTO MONTADO P13



MANGUEIRA TRANÇADA





REGISTRO MONTADO P/ BOTTIÃO DE GÁS

PALM ROSCA
30444 GROSSA P13 1/4



PALM ROSCA
30446 FINA P2 1/4
30447 FINA P2 5/16



PALM ROSCA
30445 GROSSA P3 5/16



BORBOLETA ZAMAC

PALM ROSCA
30436 GROSSA P3
P/ BOTTIÃO DE GÁS



REGISTRO DESTORCEDOR P/ BOTTIÃO DE GÁS

PALM
30438
ROSCA GROSSA
P13 - 1/4



PALM
30443
ROSCA GROSSA
P13 - 5/16



PINO ALUMÍNIO P/ PAINEL DE PRESSÃO

PALM
30506
NIGRO



PALM
30507
ROCHEDO



PALM
30504
CLOCK ATUAL
PANEX



PALM
30505
GLOBO



PESO P/ PAINEL DE PRESSÃO

PALM
30463
CROMADO SIMPLES
P/ CLOCK ANTIGA



PALM
30464
CAPA PLÁSTICA
PRETO P/ CLOCK



PALM
30468
CAPA PLÁSTICA
VERMELHO P/ GLOBO



PALM
30469
CROMADO SIMPLES
P/ GLOBO



PALM
30483
CAPA PLÁSTICA
PRETO UNIVERSAL



PALM
30484
CAPA PLÁSTICA
VERMELHO UNIV.



PESO P/ PAINEL DE PRESSÃO

PALM
30465
CAPA PLÁSTICA
VERMELHO P/ CLOCK



PALM
30466
P/ CLOCK MODERNA
CAPA PLÁSTICA
VERMELHO/PRETO



PALM
30471
CROMADO/PRETO P/
ROCHEDO SIMPLES



SELO REPETITIVO P/ PAINEL DE PRESSÃO ALUMÍNIO

PALM
30508
CLOCK



PALM
30509
NIGRO



PALM
30510
PANEX



PALM
30511
ROCHEDO



SELO REPETITIVO P/ PAINEL DE PRESSÃO SILICONE AZUL

PALM
30512
ROCHEDO/NIGRO



PALM
30514
ROCHEDÃO



PALM
30517
UNIVERSAL



SELO REPETITIVO P/ PAINEL DE PRESSÃO

PALM
30516
ROCHEDO



LIGUINHA COLORIDA



P/ ALIMENTOS
E DINHEIRO

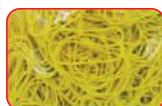

PALM
13664
1Kg

CANETA MAGNÉTICA TELESCÓPICA - 24"



Expande a até 61 cm

PALM
26022

Ideal para recuperar peças e parafusos em locais de difícil acesso



PONTA MAGNÉTICA

Corpo em Alumínio



FERRAGENS

UM MIX DE PRODUTOS PARA VOCÊ

ORCA®

DISTRIBUIDORA

PONTEIRA BORRACHA

PALM	TAMANHO
28603	1/2"
28624	3/4"
28563	5/8"
28564	7/8"
17675	1"

P/ PÉS DE CADEIRA/MESA (MACIA)



ADESIVO PROTETOR EVA 18 PEÇAS

PALM	TAMANHO	COR	PALM	TAMANHO	COR
26057	3,0cm	PRETO	26061	3,0cm	PRETO
26055	2,5cm	PRETO	26059	2,5cm	PRETO
26056	3,0cm	MARROM	26060	3,0cm	MARROM
26054	2,5cm	MARROM QUADRADO	26058	2,5cm	MARROM REDONDO

P/ PROTEÇÃO DE PISOS, PAREDES E OUTRAS SUPERFÍCIES CONTRA RISCOS E MARCAS. APLIQUE SOB OS PÉS DE CADEIRAS, MESAS, CAMAS E MÓVEIS EM GERAL



ADESIVO PVC ANTI IMPACTO

PALM	TAMANHO	QTDE
26050	8cm	24
26051	12cm	24
26052	18cm	12

TRANSPARENTE

UTILIZADO P/ PROTEGER PAREDES E OUTRAS SUPERFÍCIES CONTRA MARCAS, RISCOS, IMPACTOS EM AMBIENTES RESIDENCIAIS E CORPORATIVOS.



TELA PLÁSTICA HEXAGONAL

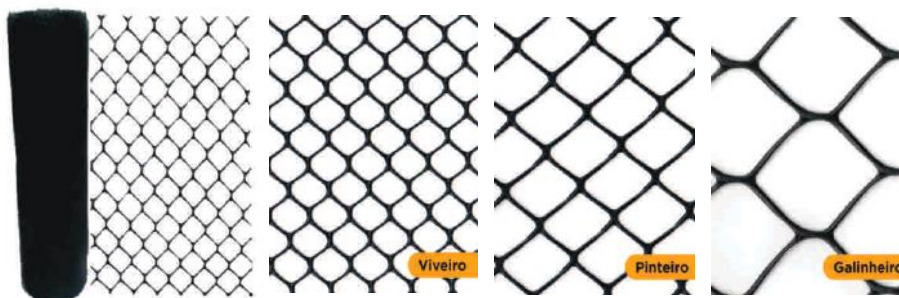

PALM	MEDIDA	PESO	METRAGEM*	TIPO
29669	1,00x50	8,300	50	VIVEIRO 1/2
29670	1,50x50	12,300	75	VIVEIRO 1/2
29671	1,50x50	9,100	75	PINTEIRO 1"
29672	1,00x50	13,400	50	PINTEIRO 1"
29673	1,50x50	13,400	75	GALINHEIRO 2"

TELA CIRANDA EM AÇO GALVANIZADO

FABRICAÇÃO DE PENEIRAS, NA CONSTRUÇÃO CIVIL P/ PENEIRAR BARRO, AREIA E PROTEÇÃO DE CALHAS, NA AGROPECUÁRIA EM CERCAS DE PROTEÇÃO DE JARDINS E HORTAS, CONFECCÃO DE PEQUENOS VIVEIROS E OUTRAS APLICAÇÕES.

PALM
28102
ARROZ/AREIA - 1X12,5M
MALHA 10 FIO 28

QUALIDADE STRONGFER
Cada vez mais forte, cada vez mais strong.

PALM
28104
FEIJÃO - 1X12,5M
MALHA 6 FIO 24

QUALIDADE STRONGFER
Cada vez mais forte, cada vez mais strong.

PALM DESCRIÇÃO
28107 Malha 4 - Fio 22
CAFÉ - 1X12,5M

PALM DESCRIÇÃO
28106 Malha 4 - Fio 22
CAFÉ - 0,80X12,5M

PALM DESCRIÇÃO
28105 Malha 4 - Fio 22
CAFÉ - 0,60X12,5M

QUALIDADE STRONGFER
Cada vez mais forte, cada vez mais strong.

PALM DESCRIÇÃO
28778 3" Fio 16 0,80x50m
28779 3" Fio 16 1,00x50m
28780 3" Fio 16 1,50x50m

MANGUEIRO

QUALIDADE STRONGFER
Cada vez mais forte, cada vez mais strong.

ABNT NBR 10122
ASSOCIAÇÃO BRASILEIRA DE NORMAS TÉCNICAS

PALM DESCRIÇÃO
28096 3" Fio 18 0,80x50m
28098 3" Fio 18 1,00x50m
28099 3" Fio 18 1,20x50m
28100 3" Fio 18 1,50x50m
28101 3" Fio 18 1,80x50m

MANGUEIRO

TELA HEXAGONAL

PALM
28093
PINTEIRO
1" FIO 23 - 1,50X50M

PALM
28091
PINTEIRO
1" FIO 24 - 1,50X50M

QUALIDADE STRONGFER
Cada vez mais forte, cada vez mais strong.

ABNT NBR 10122
ASSOCIAÇÃO BRASILEIRA DE NORMAS TÉCNICAS

PALM
28092
PINTEIRO
1" FIO 23 - 1,00X50M

PALM
28090
PINTEIRO
1" FIO 24 - 1,00X50M

QUALIDADE STRONGFER
Cada vez mais forte, cada vez mais strong.

ABNT NBR 10122
ASSOCIAÇÃO BRASILEIRA DE NORMAS TÉCNICAS

PALM
28095
VIVEIRO
1/2" FIO 26 1,00X50M

PALM
28094
VIVEIRO
1/2" FIO 26 0,80X50M

QUALIDADE STRONGFER
Cada vez mais forte, cada vez mais strong.

ABNT NBR 10122
ASSOCIAÇÃO BRASILEIRA DE NORMAS TÉCNICAS

PALM
28088
GALINHEIRO
2" FIO 23 1,50X50M

PALM
28089
GALINHEIRO
2" FIO 23 1,80X50M

QUALIDADE STRONGFER
Cada vez mais forte, cada vez mais strong.

ABNT NBR 10122
ASSOCIAÇÃO BRASILEIRA DE NORMAS TÉCNICAS

TODAS AS TELAS SÃO EM AÇO GALVANIZADO.

CORRENTE P/ MOTOSERRAS STHIL/HUSQVARNA/OUTROS



COD. DISCRICÃO
24159 3/8x1,50mm Grossa - 185 DENTES
24160 3/8x1,10mm Fina - STHIL 170 - 205 DENTES
24161 3/8x1,30mm Média - STHIL 025 - 205 DENTES
16030 3/8x1,50mm Grossa - 820 DENTES



**EMENDA P/
CORRENTE DE
MOTOSERRAS**

COD.
24532 - 0,325
24533 - 3/8x1,30mm
24534 - 3/8x1,50mm
24535 - 404x1,50

JOGO



COD. DISCRICÃO
28777 STHIL/HUSQVARNA P/ SABRE 16" ~ 3/8x1,50mm C/ 28 DENTES
28781 STHIL/HUSQVARNA P/ SABRE 16" ~ 3/8x1,50mm C/ 30 DENTES
28786 STHIL/HUSQVARNA P/ SABRE 18" ~ 3/8x1,50mm C/ 34 DENTES
28788 STHIL/HUSQVARNA P/ SABRE 20" ~ 3/8x1,50mm C/ 36 DENTES
28785 STHIL/HUSQVARNA P/ SABRE 18" ~ 3/8x1,50mm C/ 32 DENTES
28782 STHIL 08/051 P/ SABRE 17" ~ 404x1,60mm C/ 30 DENTES
28787 STHIL 08/051 P/ SABRE 21" ~ 404x1,60mm C/ 34 DENTES
28784 HUSQVARNA P/ SABRE 16" ~ 0,325x1,30mm C/ 31 DENTES

REBITADOR DE BANCADA

COD. **28765**

COD. TAMANHO
31394 3/8 - 404"
31395 325" - 3/8"
 PONTEIRA SW DO REBITADOR

ROMPEDOR/DESREBITADOR

COD. **28766**

DE BANCADA P/ CORRENTE DE MOTOSERRA (TODAS)

COD. TAMANHO
31392 3/8 - 404"
31393 325" - 3/8"
 PONTA PUNÇÃO ROMPEDOR

RATOEIRA FERRO ZINCADO

PALM TAMANHO
2475 média
2476 grande

ARMADILHA ADESIVA PEGA MOSCA

FUNÇÃO EM OUTROS INSETOS VOADORES TAMBÉM

COD. **26119**

C/ AROMA DE PEIXE PERCEPTÍVEL APENAS AO INSETOS

PAPEL CARTÃO 250gm C/ 2gm DE ADESIVO A BASE DE RESINA (N TÓXICO, N POLUENTE)

Bestfer
ARMADILHA ADESIVA PEGA MOSCA

Fácil de usar
 Captura moscas, mosquitos e outros insetos
 2 g de cola
 Papel 250 g/m²
 Produto não tóxico

RATOEIRA ADESIVA C/ AROMA DE AMENDOIM

UTILIZADO P/ CAPTURA DE RATOS E PRAGAS
 CAPTURA MAIS DE UM ANIMAL POR RATOEIRA

COD. **26117**
 22,8X37,6CM

PAPEL CARTÃO (250gm) C/ 2gm DE ADESIVO A BASE DE RESINA (NÃO TÓXICO, NÃO POLUENTE)

Bestfer
RATOEIRA ADESIVA

Fácil de usar
 Captura mais de um animal por ratoeira
 18 g de cola
 Papel 400 g/m²
 Produto não tóxico

Aroma de Amendoim

COD. **26118**
 21,2X31,8CM

PAPEL CARTÃO 1300gm C/ 25gm DE ADESIVO A BASE DE RESINA (N TÓXICO, N POLUENTE)

Bestfer
RATOEIRA ADESIVA

Alta qualidade! Super reforçado

Fácil de usar
 Captura mais de um animal por ratoeira
 25 g de cola
 Papel 1.300 g/m²
 Produto não tóxico

Com aroma de amendoim como isca

SUPER REFORÇADO